

MEDICAL DEVICES

APPLIX]
SMART

Enteral Feeding Pump

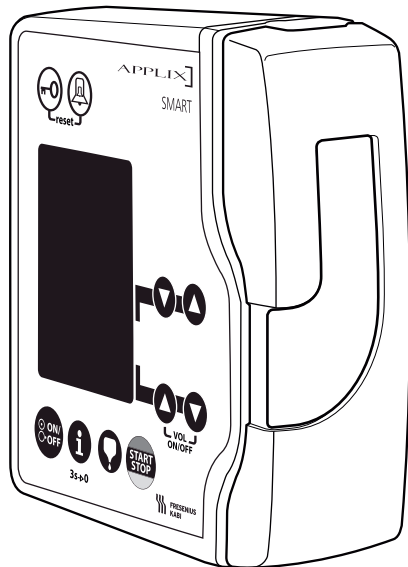

GB

INSTRUCTIONS FOR USE



**FRESENIUS
KABI**

caring for life

Operating instructions for APPLIX Smart

Please read the following instructions before using the pump.

Information	4
Intended purpose	4
Indication	4
Contraindications	4
Complications	4
Important notes	5
Description	6
Illustration of the pump	6
Pump holder and pump	7
Attaching the pump to the pump holder	8
Nurse call	9
Giving set	10
Priming of the giving set	10
Installing the giving set in the pump	12
Keypad	13
Starting up the pump	18
Mains operation	18
Battery operation	18
Switch on	18
Insert giving set	19
Automatic priming using the pump	19
Start	19
Stop	19
Switch off	19

<i>Administration programme</i>	20
Continuous programme	20
<i>Alarms</i>	22
<i>Cleaning the pump</i>	29
Pump and pump holder	29
Pump door	29
Pump mechanism and sensor area	30
<i>Technical information</i>	31
Technical data	31
Operating conditions	33
Warranty	35
Inspection	35
Repair	35
Contact	36
Explanation of symbols	37
Guidance and manufacturer's declaration	38
<i>Ordering information</i>	42

Valid for software version 5.1.

INFORMATION

Intended purpose

*The **APPLIX** Smart is intended exclusively for enteral feeding.*

*The **APPLIX** Smart pump is a peristaltic pump delivering enteral nutrition and hydration to the patient through a feeding tube.*

It can be used with both home patients and hospital patients and is a very simple pump to operate.

*The **APPLIX** Smart has a continuous feeding administration programme and several functions for patient safety.*

Indication

- Only suitable for enteral feeding.
- The user should refer to the operating conditions (see p. 33), in order to check that the use of the APPLIX pump is compatible with the clinical condition of the patient, particularly on infants and neonates.
- Due to the diversity of the use conditions with a wide range of solution characteristics (density, viscosity, quantity of dissolved gasses, rheology, particles, temperature, individualized nutrition preparation, ...), the performance of the occlusion detection may not be granted under all circumstances. Therefore Fresenius Kabi recommends not using the Applix device without a timely and regular surveillance especially when an interruption of the nutrition delivery may lead to a patient hazard (e.g. comatose situation).
- The pump must only be used by trained users both on using and cleaning the pump.
- Keep the pump, sets and wall plug away from unsupervised children (and animals).

Contraindications

- Do not use for the intravenous administration of infusions.
- Do not use if enteral feeding is contraindicated (e.g. ileus, uncontrolled diarrhoea, severe acute pancreatitis or intestinal atony) or the patient needs to be fed parenterally.

Complications

- Even with pump assisted feeding, problems such as diarrhoea or a bloated feeling may arise. The speed of administration must be adapted individually to the patient. Regular checks are required.

Important notes

- The **APPLIX** Smart is intended solely for enteral feeding.
- When using the pump, please note the operating conditions (see p. 33).
- The function of the pump is guaranteed only if it is operated with the appropriate Fresenius Kabi giving sets, (see ordering information on p. 42), and if the giving set is correctly installed (see installing the giving set in the pump p. 12). Otherwise patients may be put at risk under certain circumstances.

The giving sets should be single use only for no longer than 24 hours as depicted by British Standard EN 1615.

- The feeding tube should be flushed through before and after every administration of feed and before, between and after the administration of individual drugs.
- The **APPLIX** Smart may not be operated in areas where there is a risk of explosion.
- The feeding pump has a BF-classification. To conform with CF requirements in a cardiac environment where the patient has direct cardiac access, keep the pump attached on its holder.
- When changing the nutrition bag/bottle/container without changing the giving set, it is recommended to open the door of the pump and check the right position of the set before starting the pump again.
- In case of prolonged storage of the device, check the general aspect of this one in order to make sure it is in good condition.

DESCRIPTION

Illustration of the pump

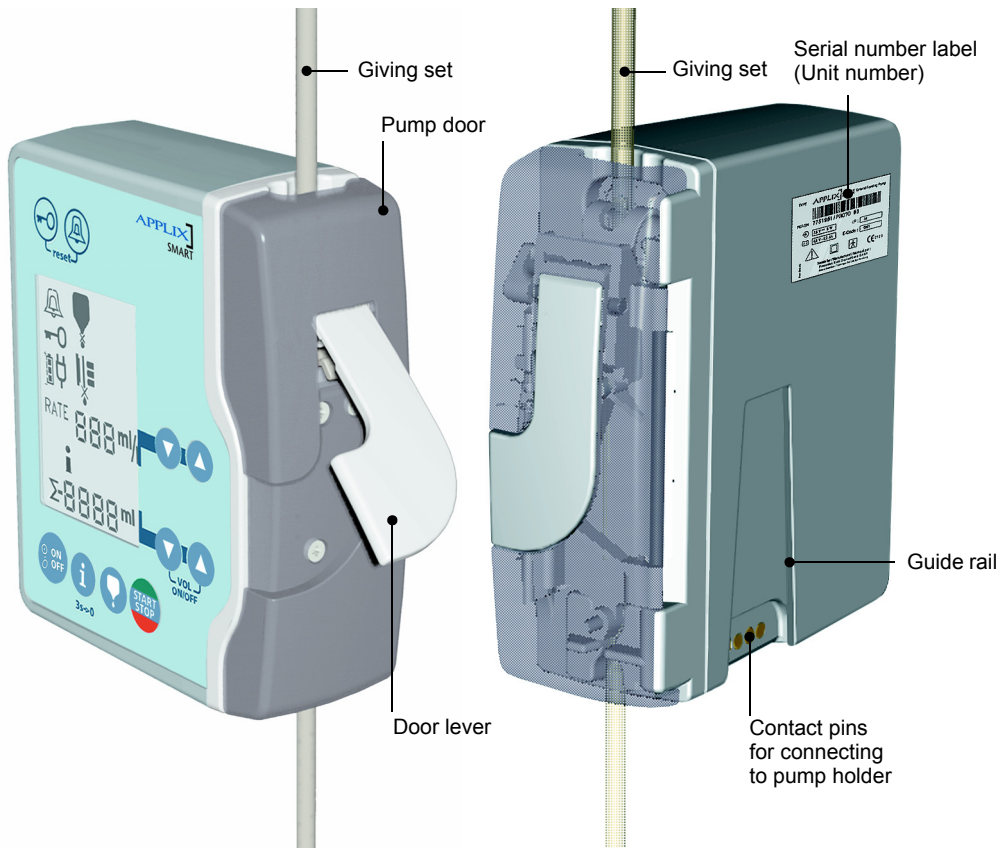

View from the front

View from the rear

Pump holder and pump

The pump can be attached universally, vertically and horizontally to both round and square rails.

E.g.:

- drip stands
- wheelchairs
- hospital beds
- table-top pump stand

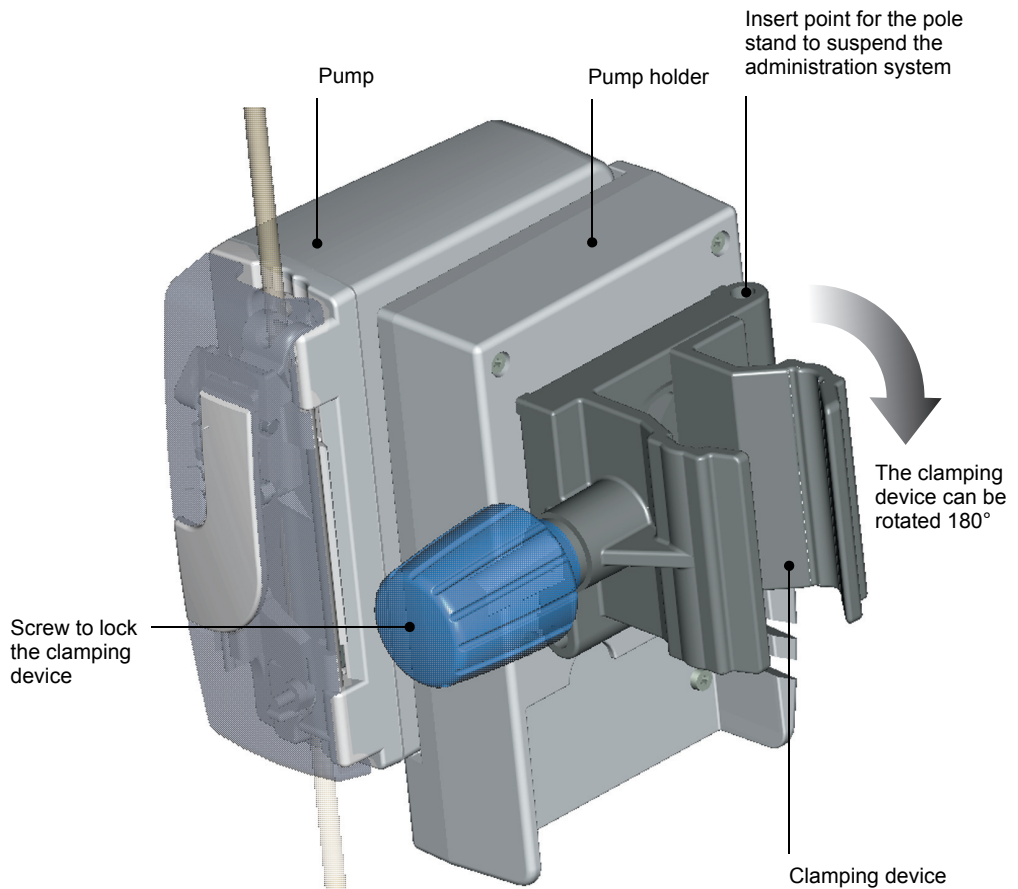

Attaching the pump to the pump holder

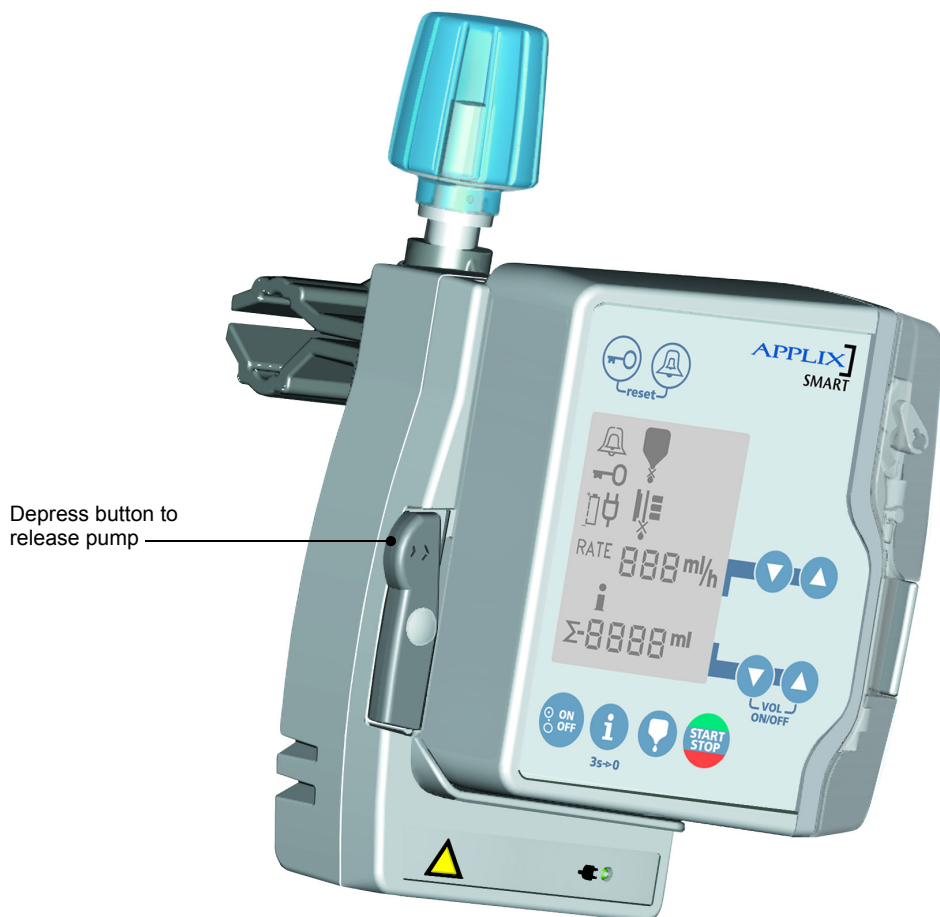

Nurse call

The pump holder provides the opportunity of connecting to a nurse call system.

- The function is available if the pump is properly engaged in the holder and the holder is connected to the mains.
- Plug the connecting cable for the nurse call function into the connector on the holder and guide through the lateral cable fixing. Then connect to the nurse call system.
- Before using the pump, check that the transfer line for the nurse call system is working properly by initiating an alarm (e.g. start without giving set) at the pump.

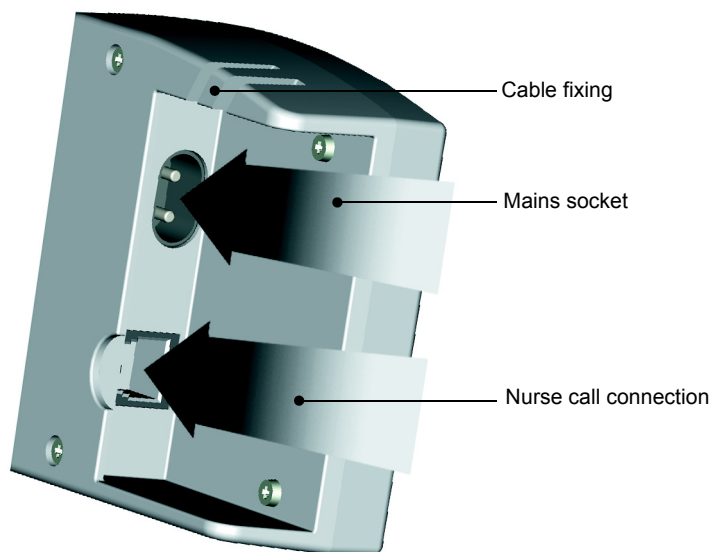

GIVING SET

Priming of the giving set

for example: **APPLIX Smart Pump Set VarioLine**

APPLIX Smart - Pump Set VarioLine

(product number 7751691)

WARNING! Operate the pump only with the appropriate Fresenius Kabi APPLIX giving sets (see Ordering information on p. 42). Otherwise administration problems cannot be ruled out.

CAUTION: The fluid in the giving set and the bag/bottle must be within normal temperature conditions: +13°/+40°C.

DANGER! Respect the appropriate positions between patient, pump, giving set and container. Check the stability of the whole system. If the container is positioned lower than 0.5 meter beneath the pump, this can lead to flow rate deviation.

WARNING! Give particular attention to the risk of strangulation with cables and sets.

NOTE: When opening the pump door, the tube clamp is closed automatically (free-flow prevention device).

1. Close tube clamp.
2. Connect food container to giving set and hang up.
3. Fill drip chamber half full by pressing gently.

4. Use preferably the automated priming process:

Ensure that the set is correctly installed in the pump prior to closing the door, (see page 12 "Installing the giving set in the pump").

5. Close the door by pushing firmly on the grey door-lever.
6. Press the automated priming key: keep the priming key depressed. Prime to the end of the giving set.
7. Release the key once priming is completed.

Verify the flow by checking the liquid flow in the drip chamber after starting the pump.

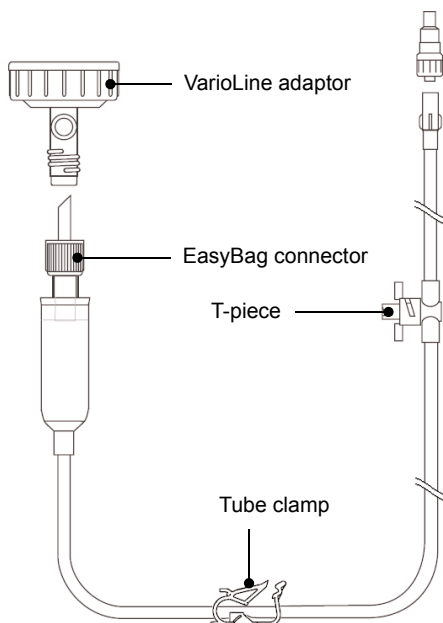

NOTE:

When priming the set manually, the steps following step n° 3 above are:

4. Open tube clamp. Prime to the end of the giving set.
5. Close tube clamp.
6. Install the set in the pump to start nutrition administration (see "Installing the giving set in the pump", page 12 and "starting up the pump", page 18).

Verify the flow by checking the liquid flow in the drip chamber after starting the pump.

NOTE: For giving sets without drip chamber, use only the automatic priming.

Installing the giving set in the pump

1. Unlock and open the pump door with the door lever.
2. Insert the tube clamp on the giving set into the pump in accordance with the arrow marking, with the clamp lever pointing upwards.
3. Guide the giving set over the pump mechanism and fix it in the lower tube guide ensuring that it is in a straight line and slightly stretched but not elongated.
4. Push the pump door shut and ensure that it engages properly.

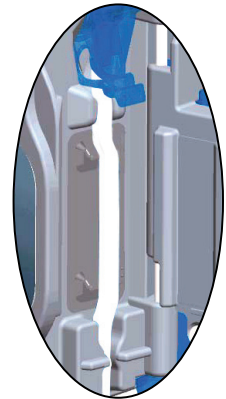
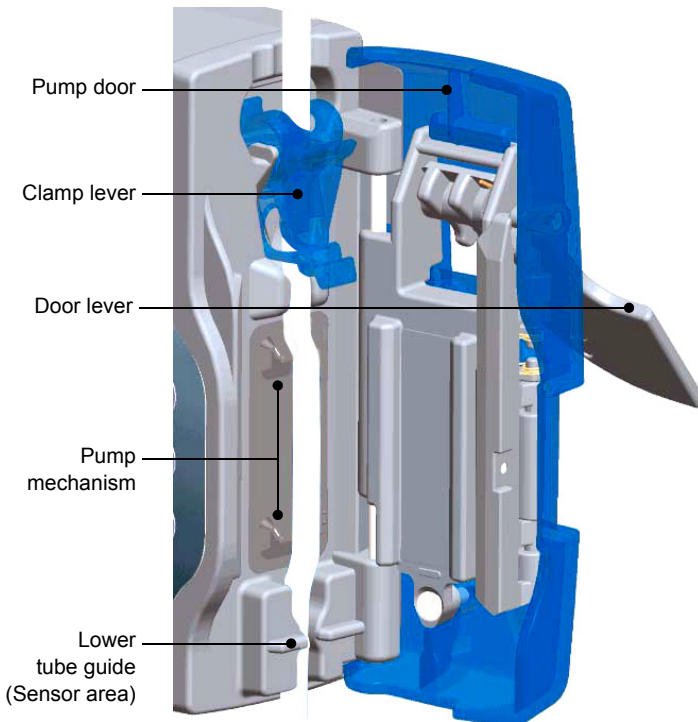



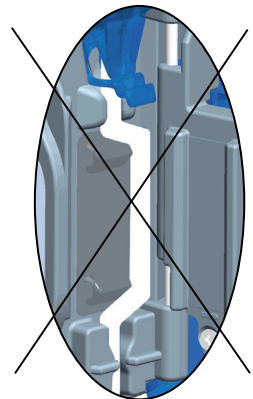







Giving set correctly installed







Giving set incorrectly installed





KEYPAD

Keys	Symbol	Operation	Function
On/Off		Press key for at least 1 second	Pump switches on (self-test) or pump switches off.
Automatic priming		Keep key depressed	Initially fill giving set with feed (600 ml/h). Release key once priming is complete.
Set rate		Press keys	Up arrow key increases. Down arrow key decreases.
Target volume On/Off		Press keys simultaneously	Activates target volume function or switches off target volume function.
		Press keys individually	Sets target volume.
Start/Stop		Press key	Starts administration or stops administration: STOP appears in the bottom display cell for 3 seconds. (During which time parameters cannot be changed).
Reset		Press keys simultaneously	<i>The following functions are available only if the pump is stopped:</i> Pump returns to original factory settings of continuous feeding at a rate of 100 ml/h.

Keys	Symbol	Operation	Function
Keypad lockout			All key functions except ON/OFF and START/STOP can be locked or released.
		Press key	Key symbol in display flashes.
		Set code 7 using top set of arrow keys	
		Press key again	Key symbol in display: <ul style="list-style-type: none"> ■ appears: keypad is locked ■ disappears: keypad is released
Alarm volume		Press key (repeatedly to alter alarm volume)	Set at different volumes. The selected setting can be both seen and heard.
		In alarm mode: Press key (once to snooze the alarm)	The alarm remains silent for 2 minutes. The Backlight and the error message keep on flashing on the display.

Keys	Symbol	Operation	Function
Information display		Press key briefly	The following information is automatically displayed if the information key is actuated in the sequence described.
<ul style="list-style-type: none"> ■ when option Target volume countdown is not activated 		When administering feed	<ol style="list-style-type: none"> 1. Volume Σ of feed administered since the pump was last reset. 2. Remaining volume Σ_- of feed to be delivered before the target volume is reached (if target volume is activated).
		When pump is stopped	<ol style="list-style-type: none"> 1. Volume Σ of feed administered since the pump was last reset. 2. The icons corresponding to the last alarm triggered are shown on the display.
<ul style="list-style-type: none"> ■ when option Target volume countdown is activated 		When administering feed	<ol style="list-style-type: none"> 1. Volume Σ of feed administered since the pump was last reset. 2. Programed target volume Σ to be delivered for this application (if target volume is activated).
		When pump is stopped	<ol style="list-style-type: none"> 1. Volume Σ of feed administered since the pump was last reset. 2. Programed target volume Σ to be delivered for this application (if target volume is activated). 3. The icons corresponding to the last alarm triggered are shown on the display.

Keys	Symbol	Operation	Function
To reset Information display		Keep key depressed for 3 seconds	Reset volume display.
Time set up between 2 alarm signals		Press key	<i>The user can select the time between two alarm signals (except for reminder and battery pre-alarm).</i>
		Set code 15 using top set of arrow keys	Key symbol in display flashes.
		Set time (from 5 to 300 seconds) using bottom set of arrow keys	Time in display appears. <i>Note: This option is only available if there is no administration in progress.</i> <i>To cancel administration, press the 'i' key 3 seconds.</i>
		Press key again	

Keys	Symbol	Operation	Function
Target volume countdown option		Press key	<p>When programming the administration with a target volume, the user can choose to display the countdown of the programmed target volume during the administration, instead of displaying the target volume programmed.</p>
		Set code 26 using top set of arrow keys	<p>Key symbol in display flashes.</p> <p>Symbol "Σ-" appears in display, before the target volume to be administered.</p>
		Select "on" using bottom set of arrow keys	<p>In this option, there is no automatic reset of the volume infused if the administration has been interrupted and/or the pump has been switched off (to reset the remaining volume to be infused, press the 'i' button during 3 seconds. A reset of the volume will also occur in case of reset to return to original factory settings).</p>
		Press key again	<p>To select the displaying of the target volume instead of the countdown, repeat the operation and select "off" with the bottom set of arrow keys.</p>

Please note that the pumps are delivered with the configuration displaying the target volume programmed per default.

Note: This option is only available if there is no administration in progress. To cancel administration, press the 'i' key 3 seconds.

STARTING UP THE PUMP

Mains operation

With pump holder and mains lead

1. Push the pump onto the guide rail of the holder until it clicks.
2. Plug the mains lead into the mains connector on the holder. (see page 9).
3. Connect the mains lead to the mains (the green "Mains" indicator on the holder comes on). The "Plug" symbol appears in the display.

Battery operation

Battery life: 24 hrs
Rate: 125 ml/h

Battery is full



Battery is empty



Before starting for the first time, charge the batteries for approx. 5 hours!

If the pump is connected to the mains, the batteries also charge during operation. When the pump is disconnected from the mains, it automatically switches to battery mode.

The maximum life of the batteries is only achieved after several charge/discharge cycles. In the event of frequent mains operation, battery life may be less. Battery indicator shows 3 bars when fully charged.

The "battery pre-alarm" will be activated when there is at least 30 minutes of battery life (or charge) remaining. If the pump is not connected to an electrical power source to recharge during the pre-alarm, the pump will stand by and the "battery alarm" will activate for 10 minutes. If at this time the battery is not recharged, it will shut off.

Switch on

Press key for approx 1 second



An acoustic signal sounds. The pump performs a self-test. The numbers 1-4 and then all the display symbols appear.

The user should have a look at the display during the self test, in order to detect potential failures.

The last feeding program activated including settings is displayed.

Insert giving set

(See page 12)

Automatic priming using the pump

Keep key depressed



Prime to the end of the giving set
(Release key once priming is complete).

Start

Press key



Flashing bars and drops indicate the start of feed/fluid administration (*).

Stop

Press key



STOP appears in the display.

Switch off

Keep depressed for approx.
1 second



In mains mode, the "Plug" symbol is visible in the display.
The pump retains all information when switched off.
This information is saved for 1 month provided the battery was fully charged at switch off.

(* In order to detect an upstream occlusion occurred before starting the pump, the **APPLIX** Smart delivers a small initial volume at a higher rate, right after START, if the door has been previously opened or an upstream occlusion alarm has been triggered (see Operating conditions p. 33).

ADMINISTRATION PROGRAMME

Continuous programme

Continuous Administering feed at a continuous speed (with activated target volume if appropriate).

Parameter	Definition of term	Setting range	Increments
Rate:	Speed of administration	1... 600 ml/h	1 or 5 ml/h
Target volume if appropriate:	Total volume of feed selected. An alarm sounds when the target volume is reached.	1... 5000 ml	1 or 10 ml

Example settings

Target volume	Rate
1. 1500 ml	150 ml/h
2. 500 ml	50 ml/h

Pump calculations

Duration of administration
10 h
10 h

Example 2

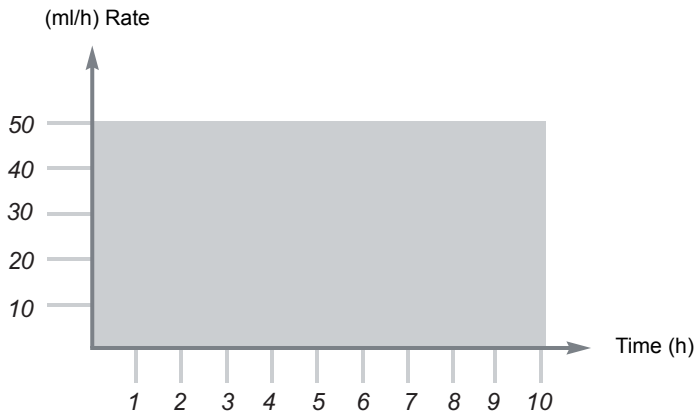

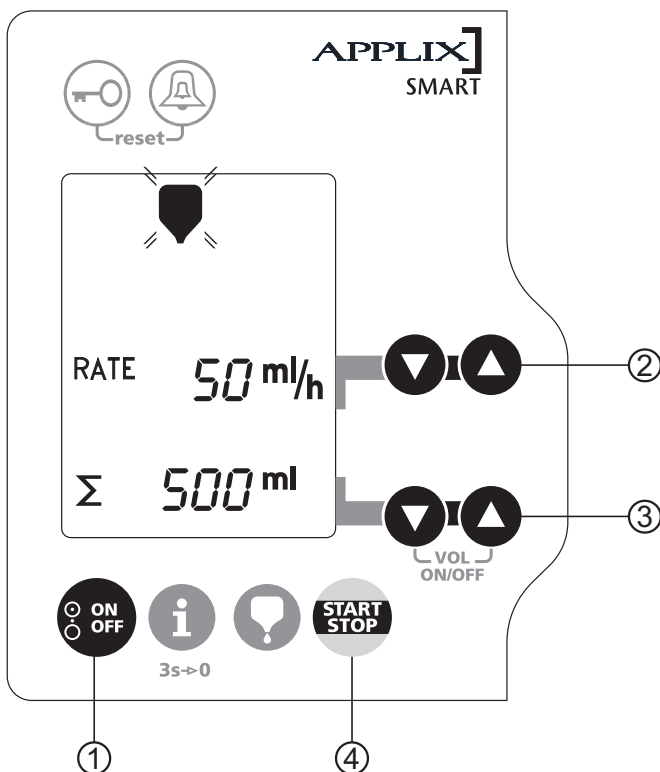

- | | |
|------------------------------------|---|
| ① Switch on pump | Press key for 1 second. |
| ② Set rate | Press keys until desired amount is reached. |
| ③ Set target volume if appropriate | Press both keys simultaneously, the symbol Σ appears. Press keys individually until desired amount is reached. |
| ④ Start programme | Press key.
Flashing bars and drops indicate the start of the programme. |

ALARMS





ALARM FUNCTIONS



Every alarm function stops the pump operating. The function is indicated visually by flashing symbols and acoustically. It is possible to vary the volume (see p.14). The loudest setting results in a continuous alarm.





Procedure:

- Stop alarm using the START/STOP key.
- Eliminate the cause of the alarm.
- Restart administration using the START/STOP key.

Alarm	Symbol	Cause	Remedy
Battery alarm in mains mode		Plug symbol visible in display	
		Batteries are defective.	Inform personnel who service pumps. Batteries should be changed by authorised engineers only!
		Plug symbol not visible in display	
		<ul style="list-style-type: none"> ■ Mains control indicator on pump holder does not come on. Faulty mains connection. ■ Mains control indicator on pump holder comes on. Pump is not properly inserted in pump holder. 	<p>Check that mains cable is properly fixed in position and is not damaged in any way.</p> <p>Insert pump in pump holder. Ensure it has clicked in to place.</p>
		Contact pins of pump and pump holder are dirty.	Remove dirt with cloth and soapy water or as directed by hospital policy (see p. 29). Allow the pump to dry.

Alarm	Symbol	Cause	Remedy
Battery pre-alarm in battery operation mode		Plug symbol not visible in display Minimum battery voltage is not available. Pre-alarm sounds at least 30 minutes before battery alarm and pump stand by.	Connect pump to an electrical outlet via the pump holder. Recharge battery and operation of the pump can resume.
Battery alarm in battery mode Alarm cannot be silenced whilst in battery mode		Plug symbol not visible in display Minimum battery voltage is not available. Alarm comes on 10 minutes before batteries are completely discharged.	Connect pump to mains via the pump holder. Recharge battery and operation of the pump can resume.
Reminder Signal repeated every minute		Pump is switched on but not operated for a minute.	Start pump or switch it off.
Target volume reached		Target volume reached (feed container symbol in display is flashing). Incorrect target volume inadvertently set.	End administration or continue feeding. If no target volume is desired, deactivate target volume function by pressing the bottom two arrow keys twice. Correct target volume.

Alarm	Symbol	Cause	Remedy
Line empty		<p>Feed container and giving set are empty down to the pump.</p> <p>Giving set not adequately filled.</p> <p>Air in sensor area (with feed container full).</p> <p>Dirt in sensor area (lower tube guide).</p> <p>Giving set not inserted correctly into the container.</p>	<p>Continue or end administration and flush giving set.</p> <p>Check and release occlusion, if any, between the container and the pump. Fill giving set to the end (see p. 10).</p> <p>Open the door and gently tap bubbles out of the giving set close to the sensor. If necessary, fill giving set again until air bubbles are removed.</p> <p>Open the door and remove dirt with cloth and soapy water or as directed by hospital policy (see p. 29). Allow the pump to dry.</p> <p>Check position of giving set and insert correctly if necessary.</p>
Occlusion		<p>Giving set at pump mechanism is blocked or kinked</p> <p>■ Upstream Occlusion: giving set is blocked between the container and the pump.</p> <p>■ Downstream occlusion: giving set or feeding tube is blocked after the pump, at the patient side.</p>	<p>Open the door, check the set installation, close the door. Re-position and verify that feed flows freely after adjustment. Check that the feeding tube is clear. Flush tube if necessary.</p>

Alarm	Symbol	Cause	Remedy
Giving set		<p>Giving set inserted incorrectly or not at all.</p> <p>Area where clamp is inserted is contaminated.</p>	<p>Check position of giving set above and below the pump mechanism and insert correctly if necessary.</p> <p>Remove dirt with cloth and soapy water or as directed by hospital policy (see p. 29). Allow the pump to dry.</p>
Pump door open		<p>Pump door not properly closed at start.</p> <p>Pump door opened after start.</p> <p>Pump door removed from its anchoring.</p> <p>Door mechanism is faulty.</p>	<p>Close pump door.</p> <p>Close pump door.</p> <p>Re-hang door.</p> <p>Inform personnel who service pumps.</p>
Pump mechanism blocked		<p>Faulty pump mechanism.</p>	<p>Inform personnel who service pumps.</p>
System fault "E" plus numerical code. Continuous tone at intervals		<p>Internal equipment fault (system fault).</p>	<p>Inform personnel who service pumps.</p>

AIR ALARM DEACTIVATION

WARNING

Please check that the condition of the patient is compatible with the accuracy range of $\pm 10\%$ (between the real administered volume and the programmed volume).

For patients who get enteral nutrition parallel to IV insulin administration, the air alarm must not be deactivated.

RECOMMENDATIONS

- The target volume should be lower than -10% of the volume in the bag.
- The container should be without air ventilation (no glass or hard plastic bottle, infusion set without air vent)

The air alarm can be deactivated directly on the pump, via the parameter mode by pressing the key button (e.g. high degassing powder nutrition which may disturb the normal functioning of the pump). The access to this function is protected by 2 codes, in order to avoid involuntary deactivation of the air alarm (empty container alarm).

Additionally, in order to allow a safe administration of nutrition while the air alarm is deactivated, the APPLIX pump cannot be started without programming a target volume and without confirming each programming step.

PROGRAMMING STEPS

- Press Key button to enter the parameter mode.
- Press upper arrow keys: select code (contact your local technical department to get the code); text "air" appears on the display.
- Enter the code with bottom arrow keys.
- Press "start" to confirm the second code.
- "on" appears on the display (air alarm is activated). Select "off" on the bottom arrow keys to deactivate the air alarm.
- Press "start" to confirm.
- The message "air off" flashes on the display.
- Press "start" to confirm the message (no programming possible without confirmation) and start programming.
- The Flow rate flashes on the display: enter flow rate with the upper arrow keys.

- Press "start" to confirm the selected flow rate.
- The target volume flashes on the display: enter target volume with the bottom arrow keys.
- Press "start" to confirm the selected target volume.
- Press "start" to initiate the administration of nutrition.

The reminder alarms sound continuously during the selection of flow rate and target volume.

NOTE: The air alarm will be re-activated by resetting the pump.

To reactivate the air alarm, repeat the operation and select "on" with the bottom set of arrow keys.

CLEANING THE PUMP

Clean pump and pump holder as soon as they become contaminated with tube feed or drugs, otherwise clean once a week. Disconnect pump from the mains before cleaning. After cleaning, the unit should be left to dry for approx. 5 minutes before being started or reconnected to the mains.

Pump and pump holder

- Wipe down pump and pump holder with a damp cloth or a cloth soaked in disinfectant.
Pump and pump holder are resistant to disinfectants.
- Please dry carefully after cleaning!
ATTENTION! Do not submerge the pump into water!
- Clean contact pins (see p. 6) with cotton wool soaked in disinfectant if required.

Pump door

- Switch off pump and remove from the pump holder.
- Lift the lever on the pump door to open.
- If you push the pump door backwards, the door can be removed from the anchoring and can be cleaned separately with running water.
ATTENTION! Not for use in the dishwasher.

Pump mechanism and sensor area

- Switch off the pump and remove from the pump holder.
- Lift the lever on the pump to open the door.
- Clean the sensor area and the clamp fixture with a damp cloth and soapy water or follow local hospital policy.
- Wipe the pump mechanism with a damp cloth.

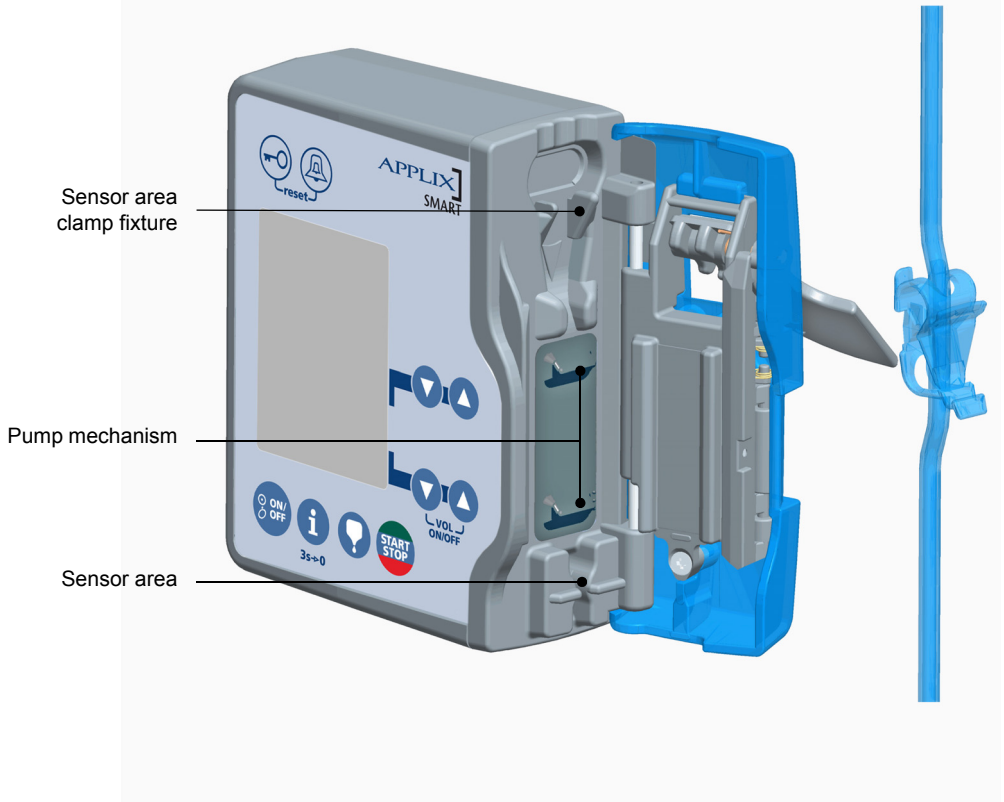

TECHNICAL INFORMATION

Technical data

Essential performance

Pump essential performances are defined as follows in standard operating conditions:

- Flow rate accuracy
(+/-10% at 300 mL/h, with medical water).
- Downstream occlusion time
(less than 2 min. at 150 mL/h, with medical water at 21°C).
- Bolus after downstream occlusion release
(less than 5 ml).

Weight

Pump: 480 g

Pump holder: 450 g

Dimensions

128 x 114 x 43 mm

146 x 162 x 115 mm

Disposal

For appropriate disposal, at the end of the device life, please contact your local Fresenius Kabi organisation or your local distributor.

Protection against electric shock

Protection class II, symbol 

Type BF, symbol 

Electromagnetic interference

This device can be disturbed by large electromagnetic fields, external electrical influences and electrostatic discharges above the limits stipulated by EN 60 601-1-2.

It can also be disturbed by pressure or pressure variations, mechanical shocks, heat ignition sources, etc. If you wish to use the device in special conditions, please contact Fresenius Kabi Ltd. This mobile RF communication equipment can affect medical electrical equipment.

Safety of ElectroMedical Equipments

Conform to EN/IEC 60 601-1

Protection against moisture

Pump

IP34 (splash-protected)

Holder

IP31 (drip-protected)

Electrical supply

Mains supply 100-230 V + 10% / 50-60 Hz
15 VA

Battery type NiMH 4.8V 1.2Ah / 1.8Ah
(Nickel-Metal Hydride)

Pump holder output 7.75 V / 800 mA

Pump battery mode 24 h at 125 ml/h

Equipment group

Ila acc. to MDD

Operating conditions

Pump, pump holder

Operating temperature	+13 to +40°C
Storage temperature	- 20 to +45°C
Max. rel. humidity	Max. 85%, no condens.
Max. operating altitude	< 3000 m

Attachment size

(vertical/horizontal)

Cylinder shape:	18-36 mm
Square shape:	10x25 mm

Deviation of rate

Max. 10% for rates > 3 ml/h

Upstream occlusion detection

Volume delivered at start:

- approx. 2 ml for rates ≤ 50 ml/h,
- approx. 4 ml for rates > 50 ml/h.

This volume is compensated within the first hour of delivery for rates > 3 ml/h. There is no compensation of the initial volume for rates ≤ 3 ml/h. Please see also "Indication", page 4.

Occlusion pressure

Max. 2 bar

Accessories/material

See contents

Mode

Suitable for continuous operation

Feeding programme

Continuous

Nurse call

Potential-free switch, 4 KV decoupling
Power output: 24 V / 100 mA to power Nurse Call

Serial communication

RS232 optical isolation 4kV

Battery recycling

To preserve the environment, remove the battery from the device prior to destruction and as during normal maintenance replacement, return it to a competent recycling organisation. Avoid short circuit and excessive temperature.

APPLIX pump noise	Inferior to 35 dB at 400 mL/h.
Downstream occlusion alarm triggering	Inferior to 2 min at 150 mL/h (with medical water).
Alarm level adjustment	From 45 dBA to 60 dBA.

WARNING! *The internal batteries should be changed every 2 years. In case of a prolonged storage period, it is recommended that the battery is removed.*

Warranty

- Pump and pump holder are guaranteed by the manufacturer for a period of 12 months from date of delivery.
- The warranty covers repair and replacement of components proven to be defective in material or workmanship.
The warranty does not extend to units that have been altered or repaired by unauthorised persons and malfunctions which are due to improper handling and wear.
- The manufacturer can only be held responsible for the safety, reliability and performance of the feeding pump if:
 - assembly, extensions, readjustments, modifications or repair have been performed by persons authorised by Fresenius Kabi,
 - the electrical installation of the site where the pump is used complies with the requirements of the IEC regulations,
 - the pump is used as specified in the Operating Instructions,
 - the pump is operated with the giving sets specified by the manufacturer.

Inspection

- The recommended maintenance interval for the **APPLIX** Smart and the pump holder is one year.
- Life cycle of Applix pump: 10 years provided that the maintenance is properly performed as described above.

Repair

- Pump and pump holder may only be repaired by the manufacturer's Pump Maintenance Department or persons authorised by them.

In the event of a fault, always send in the complete system (pump, pump holder and giving set).

Contact

UK Distributor:

Fresenius Kabi Ltd.
Cestrian Court
Eastgate Way, Manor Park
Runcorn
Cheshire
WA7 1NT
UK
www.fresenius-kabi.co.uk
for Homecare enquiries
please call: 0808 100 1990

Australian Distributor:

Pharmatel Fresenius Kabi Pty Ltd.
Unit 6, 6-18 Bridge Road
Hornsby NSW 2077
Australia
Tel: +61 2 9472 2222
www.pfk.com.au

South African Distributor:

Stand 7 Growthpoint Park
2 Tonetti Street
Midrand
South Africa
Tel: +27 11 545 0000
Fax: +27 11 545 0060

Irish Distributor:

Fresenius Kabi Ireland
Unit 3B
Fingal Bay Business Park
Balbriggan
Co. Dublin
Ireland
Tel: +353 (0) 1841-3030
Fax: +353 (0) 1849-6949

Explanation of symbols



Attention!
See instructions for use

IP 31 Drip-protected

IP 34 Splash protected



Equipment of protection class II,
insulated



Alternating current



Degree of protection against
electric shock: type BF

E-Code Features code of equipment



The CE symbol records that
the pump, pump holder, plug-in
mains unit and disposables
comply with Medical Device
Directive 93/42 EEC.

Appointed office: TÜV PRODUCT
SERVICE, MÜNCHEN, 0123



Input voltage



Output voltage



Nurse call connector



Mains connector



Recycling of obsolete batteries and devices:

Before disposal, remove battery
from the device. Batteries and
devices with this label must not be
disposed off with the general
waste. They must be collected
separately and disposed off
according to local regulations.
For further information pertaining
to waste processing regulation,
contact your local Fresenius Kabi
organisation or the local
distributor.

Guidance and manufacturer's declaration

MEDICAL ELECTRICAL EQUIPMENT needs special precautions regarding EMC and needs to be installed and put into service according to the EMC information provided below in table 201/202/204/206.

ELECTROMAGNETIC EMISSIONS – TABLE 201

The APPLIX pump is intended for use in the electromagnetic environment specified below. The user of the APPLIX pump make sure it is used in such an environment.

Emissions test	Compliance obtained by the device	Electromagnetic environment - guidance
RF emissions CISPR 11	Group 1	The APPLIX pump uses RF energy only for its internal function. Therefore, its RF emissions are very low and are not likely to cause any interference in nearby electronic equipment.
RF emissions CISPR 11	Class B	The APPLIX pump is suitable for use in all establishments, including domestic and hospital establishments and those directly connected to the public low-voltage power supply network that supplies buildings used for domestic purposes.
Harmonic emissions IEC 61000-3-2	Complies Class A	
Voltage fluctuations Flicker emissions IEC 61000-3-3	Does not apply	

ELECTROMAGNETIC IMMUNITY – TABLE 202

The APPLIX pump is intended for use in the electromagnetic environment specified below. The user of the APPLIX pump should make sure it is used in such an environment.

Immunity test	IEC 60601-1-2 Test level	Compliance level obtained by the device	Electromagnetic environment - guidance
Electrostatic Discharge (ESD) IEC 61000-4-2	± 6 kV contact ± 8 kV air	± 6 kV contact ± 8 kV air	Coatings of the floors out of wooden, tilings, and concrete, with a relative humidity level at least 30%, make it possible to guarantee the level of necessary conformity. If it is not possible to guarantee this environment, the additional precautions must be taken, such as: use of antistatic material, preliminary user discharge and the wearing of antistatic clothing.
Electrical fast Transient/burst IEC 61000-4-4	± 2 kV for power supply lines ± 1 kV for input output lines	± 2 kV for power supply lines ± 1 kV for input output lines	Mains power quality should be that of a typical domestic, commercial or hospital environment.
Surge IEC 61000-4-5	± 1 kV differential mode ± 2 kV common mode	± 1 kV differential mode Does not apply	Mains power quality should be that of a typical domestic, commercial or hospital environment. For very exposed establishments or buildings with the lightning, a protection must be installed on mains power. Class II product and no earth connexion.
Voltage dips, short interruptions and voltage variations on power supply input lines IEC 61000-4-11	< 5% Ut (> 95% dip in Ut) for 0.5 cycle	< 5% Ut (> 95% dip in Ut) for 0.5 cycle	Mains power quality should be that of a typical domestic, commercial or hospital environment.
	40% Ut (60% dip in Ut) for 5 cycles	40% Ut (60% dip in Ut) for 5 cycles	For short and long interruptions (< than battery autonomy) of power mains, the internal battery provides the continuity of service.
	70% Ut (30% dip in Ut) for 25 cycles	70% Ut (30% dip in Ut) for 25 cycles	For very long (> than battery autonomy) interruptions of power mains, the APPLIX pump must be powered from an external Uninterruptible Power Supply (UPS).
	< 5% Ut (> 95% dip in Ut) for 5 s	< 5% Ut (> 95% dip in Ut) for 5 s	Note: Ut is the a/c. main voltage prior to application of the test level.
Power frequency (50/60 Hz) magnetic field IEC 61000-4-8	3 A/m	3 A/m	If necessary, the power magnetic field should be measured in the intended installation location to make sure it is lower than the compliance level. If the measured field in the location where the APPLIX is used exceeds the applicable magnetic field compliance level above, the APPLIX pump should be observed to verify normal operation. If abnormal performance is observed, additional measures may be necessary, such as reorienting or relocating the APPLIX or install magnetic shielding.

ELECTROMAGNETIC IMMUNITY – TABLE 204

The pump is intended for use in the electromagnetic environment specified below. The user of the pump should make sure it is used in such an environment.

Immunity test	IEC 60601-1-2 Test level	Compliance level obtained by the device	Electromagnetic environment - guidance
Conducted RF IEC 61000-4-6	3 Vrms 150 kHz to 80 MHz	3 Vrms	Portable and mobile RF communications equipment should be used no closer to any part of the APPLIX pump, including cables, than the recommended separation distance calculated from the equation applicable to the frequency of transmitter. Recommended separation distance: $D = 1.2 \sqrt{P}$, for a frequency of 150 KHz to 80 MHz
Radiated RF IEC 61000-4-3	3 V/m 80 MHz to 2.5 GHz	3 V/m	$D = 1.2 \sqrt{P}$, for a frequency of 80 MHz to 800 MHz $D = 2.3 \sqrt{P}$, for a frequency of 800 MHz to 2.5 GHz where P is the maximum output power rating of the transmitter in watts (W) according to the transmitter manufacturer and D is the recommended separation distance in meters (m). Field strengths from fixed RF transmitters, as determined by an electromagnetic site survey (a), should be less than compliance level (b). Interference may occur in the vicinity of equipment marked with the following symbol: 

NOTE 1: At 80 MHz and 800 MHz, the higher frequency range applies.

NOTE 2: These guidelines may not apply in all situations. Electromagnetic propagation is affected by absorption and reflection from structures, objects and people.

- (a) Field strengths from fixed transmitters, such as base stations for radio (cellular/cordless) telephones and land mobile radios, amateur radio, AM and FM radio broadcast and TV broadcast cannot be predicted theoretically with accuracy. To access the electromagnetic environment due to the fixed RF transmitters, an electromagnetic site survey should be considered.

If the measured field strength in the location in which the APPLIX pump is used exceeds the applicable RF compliance level above, the APPLIX pump should be observed to verify normal operation. If abnormal performance is observed, additional measures may be necessary, such as re-orienting or re-locating the APPLIX pump or install magnetic shielding.

- (b) Over the frequency range 150 kHz to 80 MHz, field strengths should be less than 3 V/m.

RECOMMENDED SEPARATION DISTANCES BETWEEN PORTABLE AND MOBILE RF COMMUNICATION EQUIPMENT AND THE APPLIX PUMP – TABLE 206

The APPLIX pump is intended for use in an electromagnetic environment in which radiated RF disturbances are controlled. The user of the APPLIX pump can help prevent electromagnetic interference by maintaining a minimum distance between portable and mobile RF communications equipment (transmitters) and the APPLIX pump as recommended below, according to the maximum output power of the communication equipment.

Rated maximum output power of transmitter (W)	Separation distance according to frequency of transmitter in meters (m)		
	150 kHz to 80 MHz $d = 1.2 \sqrt{P}$	80 MHz to 800 MHz $d = 1.2 \sqrt{P}$	800 MHz to 2.5 GHz $d = 2.3 \sqrt{P}$
0.01	0.12	0.12	0.23
0.1	0.38	0.38	0.73
1	1.2	1.2	2.3
10	3.8	3.8	7.3
100	12	12	23

For transmitters rated at a maximum output power not listed above, the recommended separation distance d in metres (m) can be estimated using the equation applicable to the frequency of transmitter, where P is the maximum output power rating of the transmitter in watts (W) according to the transmitter manufacturer.

NOTE 1: At 80 MHz and 800 MHz, the separation distance for the higher frequency range applies.

NOTE 2: These guidelines may not apply in all situations. Electromagnetic propagation is affected by absorption and reflection from structures, objects and people.

The use of accessories and cables, other than those specified, can result in increased emissions or decreased immunity of the APPLIX pump.

The APPLIX pump should not be used adjacent to other equipment and that if adjacent use is necessary, the APPLIX pump should be observed to verify normal operation in the configuration in which it will be used (APPLIX pump with the holder, a main cable, a RS232 cable or a nurse call).

NOTE 3: In order to avoid perturbations, the minimum recommended distance to maintain between the device and a cellular phone is 10 centimeters.

ORDERING INFORMATION

Description

References

Pump and Accessories

APPLIX Smart INT pump	7751990
APPLIX Smart GB pump	7751911
APPLIX Smart AUS pump	7751912
APPLIX Universal Table Top Pump Stand	7751081
APPLIX Pole stand	7982071
APPLIX Mobility Kit Mini	7752341
APPLIX Mobility Kit Standard	7752321
APPLIX DuoBag	7902011
APPLIX Waistbelt	7750501

Giving sets

APPLIX Smart/Vision Bag	7751711
APPLIX Smart/Vision Bottle	7751721
APPLIX Smart/Vision EasyBag	7751731
APPLIX Smart/Vision EasyBag with cover	7752051
APPLIX Smart/Vision VarioLine	7751691
APPLIX DuoLine mobile	7752041

Information material

Technical hand book (CD-ROM)	7345851	
Instructions for use	7345771	4032
Mini reference guide	7345731	200753

*Vial
reference*

Revision date: December 2014



Fresenius Kabi AG
61346 Bad Homburg
Germany
www.fresenius-kabi.com





**FRESENIUS
KABI**

caring for life