



**FRESENIUS
KABI**

caring for life

Amika+

Enteral feeding pump

Software version 1.0

Instructions For Use



Symbol descriptions



Warning (Refer to the Instructions For Use)

CE 0123 CE mark



Refer to the Instructions For Use



Medical electrical system weight (kg)



Product reference / part number



Product serial number



Name and address of the manufacturer / Date of manufacture



Name and address of the manufacturing facility



Battery specification



Protection against leakage current; defibrillation-proof type CF applied part



Direct Current (DC)



Alternating Current (AC)



Output terminal - connector



Input terminal - connector



Fragile, handle with care



This way up



Keep away from rain



Temperature limitation



Humidity limitation



Atmospheric pressure limitation



General symbol for recyclable material



Eco packaging symbol

IP32 **Smart Holder COM:** IP32-Index of protection against solid foreign objects (> 2.5 mm) and dripping liquids

IP35 **Pump:** IP35-Index of protection against solid foreign objects (> 2.5 mm) and water jets from any direction



Part included in a recycling process



Protection against electric shock: class II



Warning: warning of a potential hazard that could result in serious personal injury and/or product damage if the written instructions are not followed.



Caution: warning of a potential hazard that could result in minor personal injury and/or product damage if the written instructions are not followed.



Information: recommendations to be followed.



INFORMATION

Please refer to the Use environment section for additional information on temperature, pressure and humidity limitations.

Table of contents

1 Introduction	5
1.1 Scope.....	5
1.2 Intended use.....	5
1.3 Intended user population.....	5
1.4 Intended patient population.....	5
1.5 Principles of Operation.....	6
1.6 Contraindications.....	6
1.7 Use environment.....	6
1.8 Specificities for Homecare Environments.....	7
2 Description	8
2.1 System definition.....	8
2.2 Packaging content.....	8
2.3 General description.....	8
2.4 Detailed description.....	9
2.5 Display description.....	11
3 Installation and removal	14
3.1 Installation.....	14
3.2 Removal.....	19
4 Operations	21
4.1 Use of internal battery.....	21
4.2 Basic operations.....	22
5 Pump menu	33
5.1 Access menus.....	33
5.2 Feeding mode and settings.....	34
5.3 Night mode.....	36
5.4 Sound.....	37
5.5 Settings lock.....	37
5.6 Cumulative feeding volume counter.....	38
5.7 Alarm history.....	39
5.8 Feeding history.....	40
5.9 Contrast / Brightness.....	40
5.10 Set time between two alarm sounds.....	41
5.11 Set time for target volume almost reached message.....	41
5.12 Technical information.....	42
5.13 Reset manufacturing settings.....	42

6 Cleaning and disinfection	44
6.1 Prohibited cleaning or disinfection agents.....	44
6.2 Precautions.....	44
6.3 Recommended cleaning and disinfection agents.....	44
6.4 Cleaning and disinfection guidelines and protocol.....	44
7 Quick check protocol	47
8 Alarms and safety features	49
8.1 Alarms / Actions.....	49
8.2 Troubleshooting.....	54
9 Technical information	56
9.1 Performance.....	56
9.2 Technical characteristics.....	57
10 Transport, storage and recycling conditions	66
10.1 Storage and transport conditions.....	66
10.2 Storage.....	66
10.3 Recycling and disposal.....	67
11 Guidance and manufacturer's declaration on EMC	68
11.1 Electromagnetic compatibility and interference guidance.....	68
11.2 Guidance and manufacturer's declaration - Electromagnetic immunity.....	69
11.3 Recommended separation distances between portable and mobile RF communication equipment and pump.....	69
12 Services	70
12.1 Warranty.....	70
12.2 Quality control.....	70
12.3 Maintenance requirements.....	71
12.4 Service policy and rules.....	71
13 Ordering information	72
13.1 Instructions for use.....	72
13.2 Giving sets.....	72
13.3 Accessories.....	72
14 Glossary of terms	74

1 Introduction

Amika+ is an enteral feeding pump with a Smart holder COM (referred to as holder) and disposables dedicated to enteral feeding and hydration. The intended use of Amika+ pump and sets is to deliver nutrition and hydration fluids to the patient through a feeding tube, in a safe, instinctive and convenient manner.

1.1 Scope

These Instructions for Use (IFU) are applicable to the Amika+ pump referred to as pump with software version 1.0.



WARNING

- Check that these IFU are applicable to the current Amika+ software version.
- The software version of the pump is displayed in the technical information menu described in *Technical information* on page 42.
- The user must follow the instructions specified in this IFU. Failure to observe these instructions may result in damage to the equipment, injury to patients or injury to users. Specific texts are highlighted using the symbols described in *Symbol descriptions* on page 2.

1.2 Intended use

Amika+ enteral feeding pump is intended for use on adults and pediatrics to deliver nutrition and hydration fluids to the patient through an enteral route of administration using a feeding tube.

It is intended for use by both qualified and trained healthcare professionals in clinical healthcare facilities, in ambulatory use with an Amika Backpack and in pre-hospital medical ground transportation and home users in homecare.

1.3 Intended user population



WARNING

Keep the pump, sets and power cable away from unsupervised children (and animals).

The pump must only be used and cleaned by trained healthcare professionals, patients or patient relatives.

It is recommended that users attend a single training session of about 60 minutes (For training, contact your Fresenius Kabi sales representative).

1.4 Intended patient population

The pump can be used on one patient at a time and on multiple patients during its lifetime.

The pump can be used on patients requiring enteral feeding and enteral hydration.

The intended patient population includes patients who get enteral nutrition parallel to IV insulin administration. Those patients require special attention during the feeding process.

1.5 Principles of Operation

The device is a peristaltic pump dedicated to enteral feeding.

The pump is used to administer to patient (humans only) a volume of nutrition at a programmed flow rate.

The feeding can be administered continuously (Continuous mode) or sequentially (Bolus mode).

The pump is designed to administer fluids through trans-nasal or percutaneous feeding tube.

The pump is designed to administer any kind of enteral nutrition fluids, including drinking water (still and sparkling), tea, soda, fresh water and the whole product range of ready nutrition from Fresenius Kabi.

1.6 Contraindications

DO NOT USE:

- for the intravenous administration of infusion fluids;
- if enteral feeding is contraindicated by medical prescription;
- with premature (born < 37 weeks of pregnancy) and neonates (<1 month);
- in Magnetic Resonance Imaging (MRI) environments;
- in ambulances, helicopters, aircrafts and hyperbaric chambers;
- in areas where there is a risk of explosion.

1.7 Use environment

The Amika+ power cable is not meant to be used outdoors (such as in the garden, on the patio).

WARNING



- Keep away from heat sources, dust, fluff, direct and prolonged light exposure.
- The pump should be used under specified operational, storage and transport conditions listed below to ensure pump performance.
- At the limit of the operating temperature range, physical properties of set's tube may change; in such condition, alarms are more likely to happen.

- Temperature operating range: 10°C to 40°C
- Storage and transport temperature: -20°C to +45°C
- Pressure operating range: 700 hPa to 1060 hPa
- Storage and transport pressure: 500 hPa to 1060 hPa
- Humidity operating range: 30% to 85%, no condensation
- Storage and transport humidity: 10% to 90%, no condensation

- Altitude: maximum 3000 m.

In case of refrigerated products, allow the product to reach the operating temperature range before use.

When the pump is stored at extreme temperature (-20°C and +45°C), wait for 2 hours to allow the product to reach the operating temperature range before using the pump. An intempesive alarm can be triggered if the pump/giving set temperature is too low or too high.

1.8 Specificities for Homecare Environments

The responsibility of using the pump is shared between the healthcare professional and the patient. All pump settings must be performed according to the medical prescription.

If any doubt, patient or patient relatives should call healthcare professional to confirm correct handling of the device.

2 Description

2.1 System definition

The Amika+ system is composed of the following components:

- Amika+ pump: enteral feeding pump with pump holder and power cable.
- Amika+ disposable (applied part): giving sets.
- Amika+ accessories.

For more information on accessories, refer to their respective accompanying documents.

2.2 Packaging content

The Amika+ packaging contains the following elements:

- 1 Amika+ pump
- 1 Smart holder COM
- 1 power cable
- 1 Nurse call Cable
- User documents

Packaging consists of: recycled cardboard.

Symbols used on Amika+ packaging are described in *Symbol descriptions* on page 2.

2.3 General description

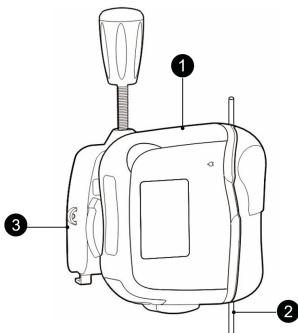

Legend

- ① Pump
- ② Giving set (sold separately)
- ③ Pump holder

2.4 Detailed description

Pump description

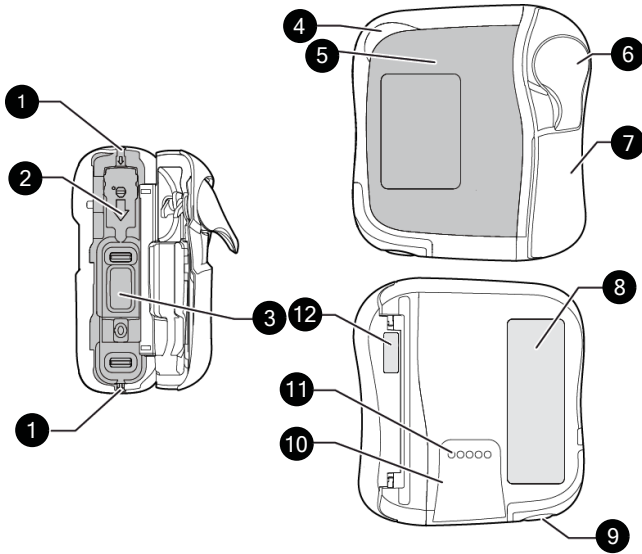

Legend

- ① Tube guides
- ② Pinch clamp slot
- ③ Pumping mechanism
- ④ Status light indicator
- ⑤ Front panel (keypad)
- ⑥ Door lever
- ⑦ Pump door
- ⑧ Pump identification label
- ⑨ Speaker
- ⑩ Rails for installation on pump holder
- ⑪ Contact pins for pump to holder connection
- ⑫ Pump door identification label

Smart Holder COM description

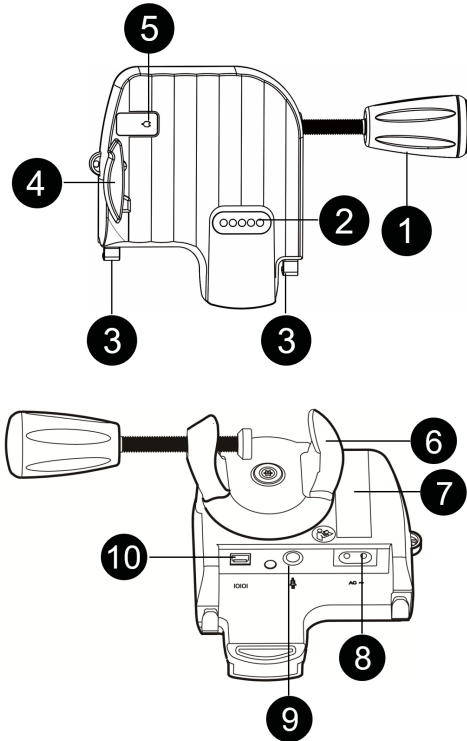

Legend

-
- ① Clamp handle
 - ② Contact pins for pump to holder connection
 - ③ Slot for cables
 - ④ Grey locking lever
 - ⑤ Mains supply light indicator
 - ⑥ Pole clamp
 - ⑦ Holder identification label
 - ⑧ Power cable inlet
 - ⑨ Nurse call connector
 - ⑩ RS232 serial communication connector
- AC~ Near the power cable inlet of the holder, description in *Power supply specifications* on page 57

Front panel (keypad) description

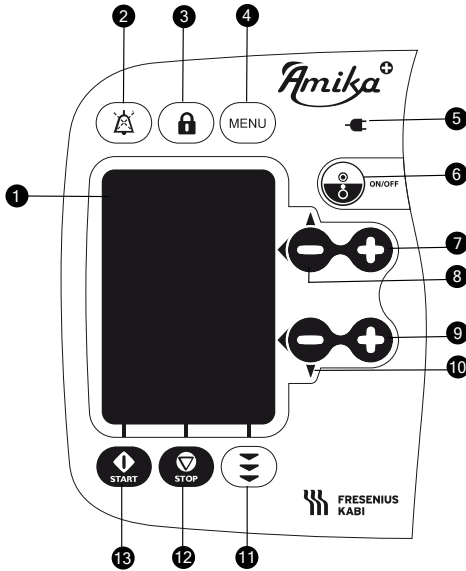

Legend

- ① Display (description next page)
- ② Mute key
- ③ Keypad lock key
- ④ Menu key
- ⑤ Mains supply light indicator
- ⑥ Power ON/OFF key
- ⑦ Flow rate Up
- ⑧ Flow rate Down / Scroll up in Menu
- ⑨ Target volume Up
- ⑩ Target volume Down / Scroll down in Menu
- ⑪ Priming function key
- ⑫ Stop / Cancel / Back key
- ⑬ Start / Enter / OK key

2.5 Display description



Status Bar icons

	Sound level icons		Alarm icon
	Battery icon		Muted alarm icon
	Keypad locked icon		Settings lock icon

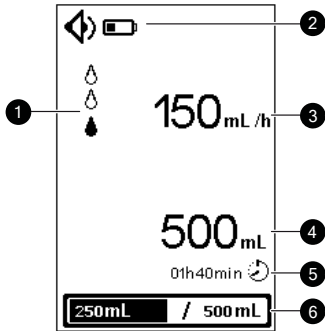
Continuous mode setting screen layout





Legend

-
- ① Pumping status indicator:
 -  Pumping is stopped
 -  Pumping is in progress
 - ② Status bar
 - ③ Flow rate
 - ④ Target volume
 - ⑤ Remaining feeding time
 - ⑥ Progress bar showing volume delivered / total volume

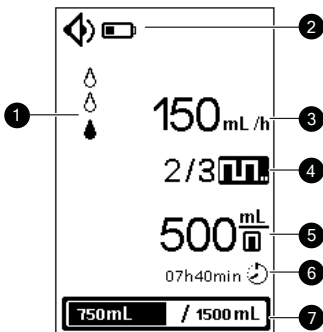
Bolus mode setting screen layout



Legend

-
- ① Pumping status indicator:
 -  Pumping is stopped
 -  Pumping is in progress
 - ② Status bar
 - ③ Flow rate
 - ④ Current bolus / Bolus number
 - ⑤ Volume per bolus
 - ⑥ Remaining feeding time of all boluses
 - ⑦ Progress bar showing volume delivered / total volume

Menu display layout

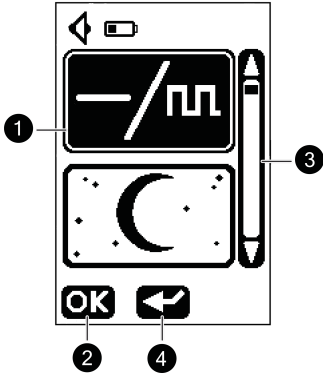

Legend

- 1 Menu list
- 2 Menu access
- 3 Scroll bar
- 4 Back

3 Installation and removal

Installation and removal must only be done when the patient is not connected.

3.1 Installation

3.1.1 Global installation

Ensure that the appropriate positions between patient, pump, giving set and container are maintained.

WARNING

- Do not vary the pump height while a patient is connected to it. This may lead to false alarms and will alter flow rate accuracy.
- Check the stability of the whole system. If the container is positioned lower than 0.5 m beneath the pump, this can lead to flow rate deviation.
- Give particular attention to the risk of strangulation with cables and sets, and with the small parts that could be swallowed or inhaled.

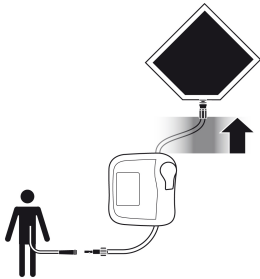

Figure 1: Recommended installation

Place the container above the pump

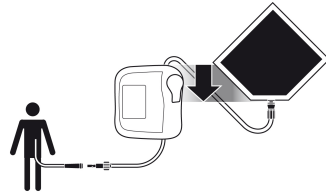

Figure 2: Possible installation

The container can be placed down to 0.5 m beneath the pump

Do not place the pump below the patient or more than 1.3 meter above the patient.

3.1.2 Using the pole clamp

The holder can be attached universally, vertically and horizontally. Turn the pole clamp to the suitable position.

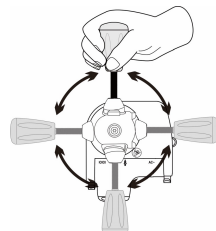

3.1.3 Positioning the holder on a rail, pole, bed or wheelchair

Ensure the holder is positioned so that the display is at the suitable height to ensure good visibility and orientation in the reading direction (the contact pins are at the bottom).

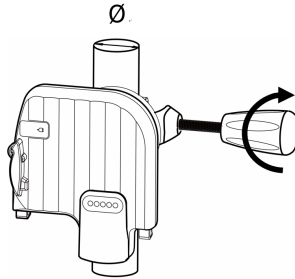
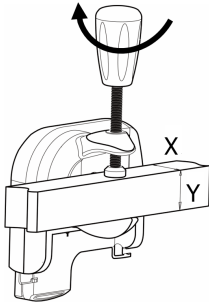

X, Y min = 10 mm
X, Y max = 35 mm
Ø min = 8 mm
Ø max = 40 mm

1. Fasten pole clamp firmly on the pole or rail to avoid any movement of the pump.
2. Ensure that the pump is securely attached and positioned.

3.1.4 Positioning the holder on a table

The holder can be placed on a flat and horizontal table as indicated in the figure.

Ensure the pump is positioned away from table edges to avoid being accidentally pushed off the table.

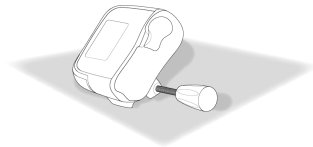

3.1.5 Positioning the pump

Slide the pump down until the grey locking lever locks the position.

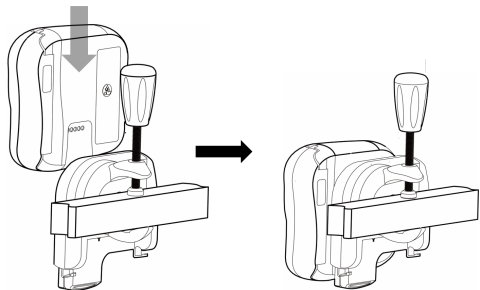

3.1.6 Electrical connection

Ensure power cable is not damaged and is compatible with local voltage range.

To charge battery or to use the pump on the mains power supply:

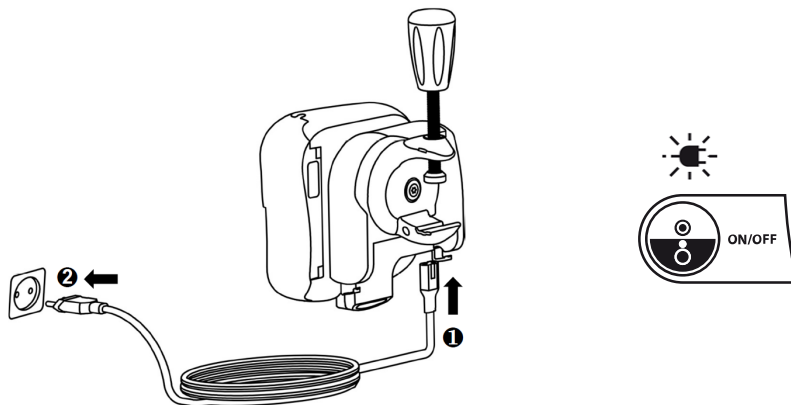

1. Connect power cable to the holder.
2. Plug the power cable to the mains socket.

When connecting to the mains, ensure that the power cable and the power socket are easily accessible.

The mains power supply is indicated by a green light on the pump's front panel (keypad).

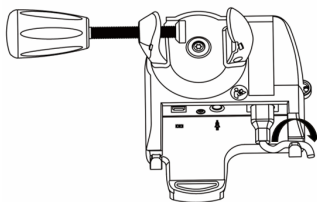

3.1.7 Connection to the Nurse Call System and Removal

The Smart Holder COM and Nurse Call cable allow the connection of an Amika+ pump to an external Nurse Call system to transmit an Amika+ pump alarm state.

The Nurse Call connection is functional only if:

- the pump is correctly installed on the holder.
- the holder is connected to the power supply.
- the Nurse Call cable is correctly plugged.

If the Nurse Call is not functional, Amika+ pump alarm state is not transmitted.

The Nurse Call system availability and technical compliance are the responsibility of the hospital.

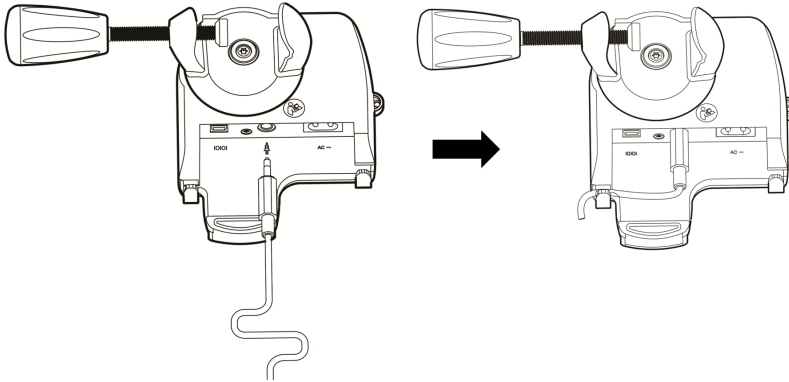

1. Connect the terminated Nurse Call cable to the holder Nurse Call connector.
2. Pinch the cable into the slot provided for this purpose.
3. Check that the nurse call system is functional by generating an alarm (eg: start the pump with no giving set installed). Ensure the pump alarm is transmitted on the connected Nurse Call system.
4. To disconnect, unplug the Nurse Call cable.



INFORMATION The nurse call cable is delivered with an unterminated side, which will require customization to the hospital-specific nurse call system by a trained technician. See Amika+ technical manual for further information.

3.1.8 Data communication overview



INFORMATION

- Ensure that all hospital information systems have been approved by Fresenius Kabi. For more information, contact your technical services representative.
- Before connecting the pump to a hospital information system, please contact your IT or biomedical department.
- Do not disconnect communication cables while data is being transferred.

Amika+ data communication feature allows:

- Communication between a hospital information system server and 1 pump.
- Connection of 1 pump to a PC for the following purposes: Maintenance (via Amika Partner software).

3.1.9 USB Maintenance cable connection and removal



INFORMATION

- USB Maintenance cable is only used to connect the pump with Amika Partner software for service activities.

- Use ONLY cables recommended by Fresenius Kabi. Refer to *Ordering information* on page 72.
- All connections and disconnections must be performed by qualified and appropriately trained staff.
- All IT devices (including computers, hubs and switches) inside the patient area (< 1.5 m) must comply with IEC/EN 60601-1 (leakage current).
- IT devices connected outside the patient area (> 1.5 m) must be at least IEC/EN 60950 compliant.
- Do not disconnect communication cables while data is being transferred.



1. Connect the terminated USB maintenance cable to the holder RS232 serial communication connector.
2. Connect the other side of the USB maintenance cable to the third party system.
3. Check communication status.
4. To disconnect, unplug the USB maintenance cable.

3.1.10 Communication with PDMS

INFORMATION



- Before connecting the pump to a hospital information system (PDMS), please contact your IT or biomedical department.
- Fresenius Kabi is not responsible of providing serial communication cable. If need, please contact your PDMS provider for serial communication cable in accordance with their specifications (DB9, USB...).
- The serial interface will automatically operational when the pump is installed on the Smart Holder COM and running.

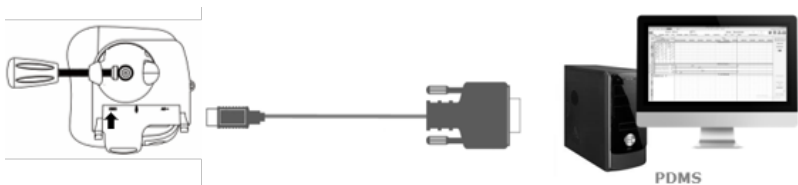

3.2 Removal

3.2.1 Removing the pump from the pump holder

1. Push the grey locking lever.
2. Pull the pump up.

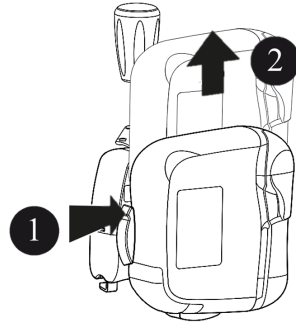

3.2.2 Removing the pump holder

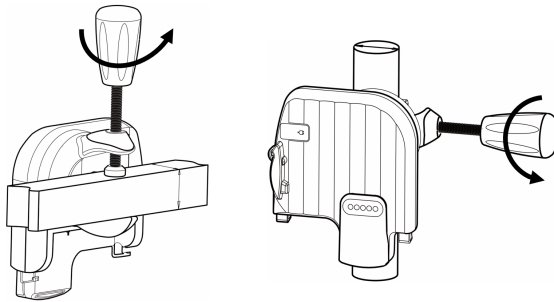

3.2.3 Electrical disconnection

1. Remove power cable from power socket.
 - A beep is emitted by the pump when the power cable is disconnected.
 - To store the pump, see *Storage* on page 66.

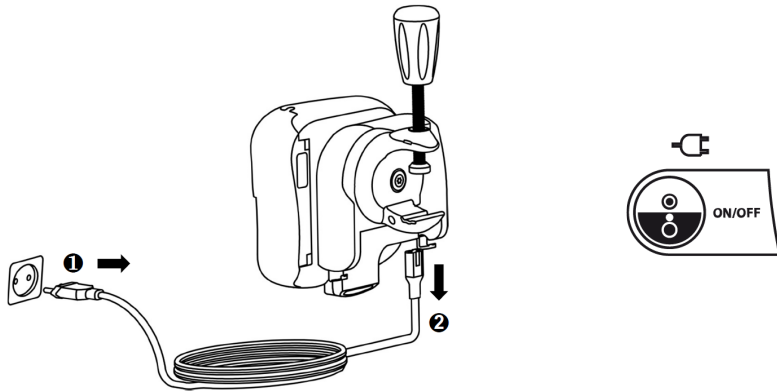

2. Remove power cable from holder.

3.2.4 Attaching / Removing the Quick Guide

A quick guide can be easily attached and removed from the pump holder.

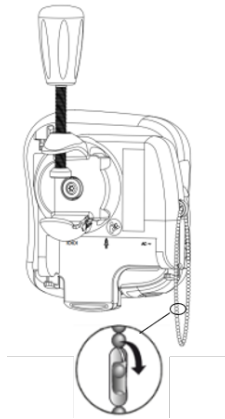

4 Operations

4.1 Use of internal battery





4.1.1 Battery precautions

Before using the pump on battery for the first time, charge the battery until it is fully charged (approximately 6 hours).

Keeping the pump connected to mains when not in use is recommended in order to maintain battery charge. The battery is charging continuously ensuring its maximum capacity.

4.1.2 Battery operating mode

The icon  is always displayed in the status bar. The device can be used while battery is charging.

Battery life	24 hours ± 5% until 125 mL/h and a minimum of 8 hours for flow rates above 125 mL/h (in standard feeding conditions, at 22.5°C ± 2.5°C)
 (green)	When the pump is connected to the mains (see <i>Electrical connection</i> on page 15) ▶ Battery charges automatically, also during operation
	When the pump is disconnected from the mains (see <i>Electrical disconnection</i> on page 19) ▶ Pump switches to Battery Mode automatically
	The battery is fully charged
	The battery is partially charged
 (flashing)	The battery is nearly empty. ▶ A visual information is triggered (see <i>Alarms / Actions</i> on page 49). When battery is empty (less than 10 minutes left), an alarm is triggered (see <i>Alarms / Actions</i> on page 49.)

INFORMATION



- To optimize battery life, set the flow rate at 125 mL/h maximum and use the pump in battery mode several times until battery is discharged ( flashing).
- If battery is failing, do not use the device. Return device to Fresenius Kabi sales representative as soon as possible.
- Battery replacement must be performed by qualified and trained technical personnel in compliance with the technical manual and procedures.
- Under normal condition of use, battery life might be reduced from 24 hours to 20 hours by the end of the third year of use.

4.2 Basic operations

Before using the pump, proceed to Quick Check Protocol (see *Quick check protocol* on page 47).

4.2.1 Switch-on

When using a pump on patient requiring special attention, ensure that a backup pump or gravity set are available for immediate use.

When switching on the pump, check that the auto test sequence is as described below.

Before switching on the pump, install holder and pump, see *Installation* on page 14.

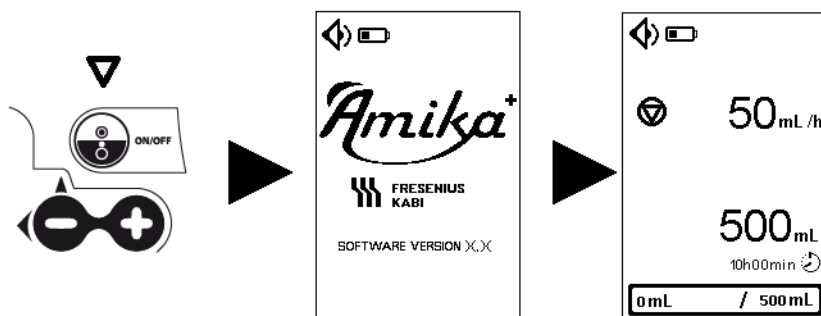

Figure 3: Auto test

During the 2-second autotest:

- red, yellow and green LEDs blink;
- beep sounds (if sound level is low, melody is playing on low, if sound level is high, melody is on high).

4.2.2 Installing the giving set

4.2.2.1 Preparing the giving set

In order to protect user health, please follow clean aseptic handling procedures for container, set or feeding tube disposal.

	WARNING
	■ Only Fresenius Kabi giving sets can guarantee pump reliability. Please refer to the compatible giving sets (see <i>Giving sets</i> on page 72) and compatible nutrition fluids (see <i>Intended use</i> on page 5).
	■ Check the giving set's intended use regarding the feeding protocol, especially for patients requiring special attention.
	■ Check giving set and patient connection integrity before use.



CAUTION

The fluid in the giving set and the bag/bottle must be within normal temperature conditions: +10°/+40°C.

4.2.2.2 Description of the pinch clamp



Pinch clamp is open



Pinch clamp is closed



INFORMATION

Patient must not be connected to the set when the pinch clamp is open.

4.2.2.3 Installing the giving set in the pump

To connect / disconnect / change the container and feeding tube to the set, refer to the giving set "Instructions for use" on primary packaging.



WARNING

For patients requiring special attention, another giving set must always be available.

1. Push up the lever to unlock the door **1**. Open the door **2**.

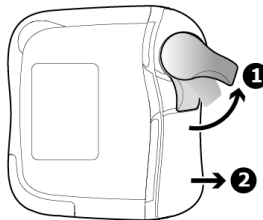

2. Position the pinch clamp using the arrow marks indicating the direction of the flow **1**.
Insert the pinch clamp until you hear the 'CLIC' **2**.

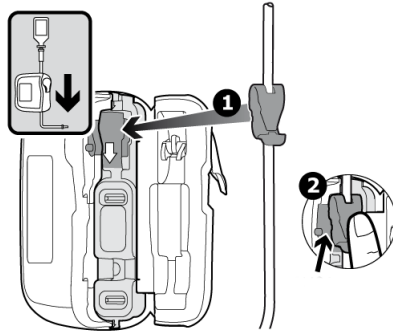

3. On the sides of the pump, place the tube straight inside tube guides.

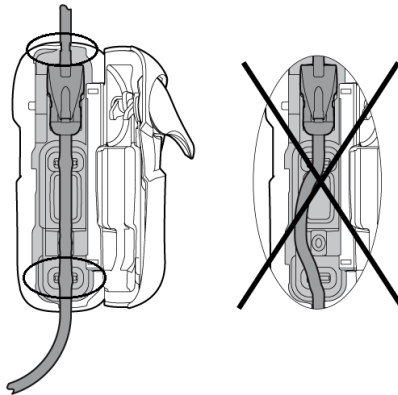

WARNING

Check that the giving set is correctly installed to avoid patient harm such as overfeeding, underfeeding.

4. Close the door **1**. Push down the lever to lock the door **2**.

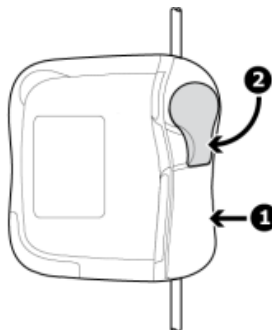



INFORMATION

When opening the pump door, the tube clamp is automatically closed (free-flow prevention system).

4.2.3 Priming the giving set



WARNING

Patient must not be connected to the pump when priming is performed.



INFORMATION

- To proceed to giving set priming, fill drip chamber half full by pressing gently.
- Ensure that liquid is flowing in the drip chamber after starting the pump.
- For giving sets without drip chamber, use only automatic priming.
- A beep sound will be heard every 30 seconds during priming.

4.2.3.1 Priming with the pump

Amika+ pump allows two priming modes:

- automatic priming: Amika+ pump automatically fills in the giving set at maximum rate by depressing the automatic priming key ;
- semi-automatic priming: Amika+ pump fills in the giving set at maximum rate as long as the semi-automatic priming key is kept depressed.



INFORMATION

Automatic and semi-automatic priming fill the giving set at a rate of 600 mL/h and are stopped after 17 mL (factory settings).

Make sure that priming is correctly completed before starting feeding.

Automatic priming

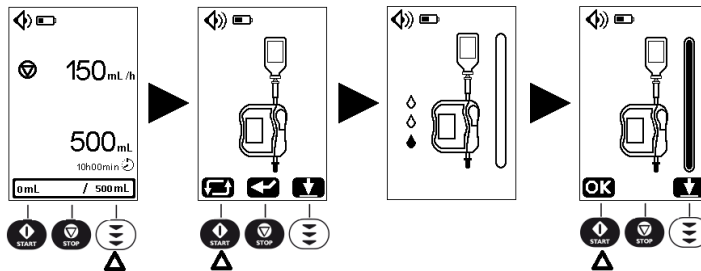

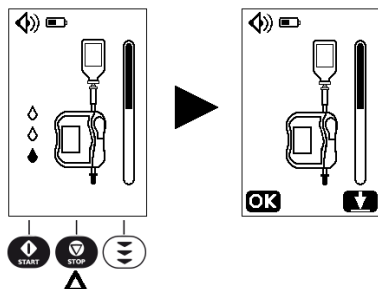

Auto priming can be stopped at any time:

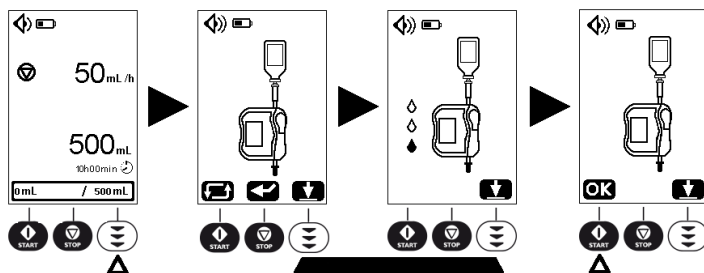

At the end of automatic priming, it is possible to continue the priming using the semi-automatic priming function as defined below.

Semi-automatic priming



Press  key to access to the priming modes. Press  key to launch the priming. Keep it depressed during priming. Release it once priming is complete.

Press  to go back to setting screen.



WARNING

At the end of priming, check that the set is correctly primed.

4.2.3.2 Priming without the pump (Manual priming)

Remove the giving set from the pump (see *Removing/Changing the giving set from the pump* on page 30).

1. Close pinch clamp.
2. Connect food container to giving set and hang up.
3. Fill drip chamber half full by pressing gently.
4. Open pinch clamp and prime to the end of the giving set.
5. Close pinch clamp.

Install the set in the pump to start feeding (see *Installing the giving set* on page 22).

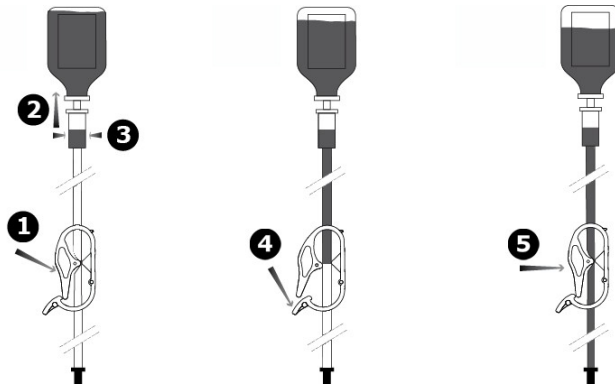

4.2.4 Change feeding setting

INFORMATION



- A longer keypress provides faster scrolling.
- The flow rate of delivery must be adapted individually to the patient. Regular checks are required.

- Adjust feeding rate (mL/h)

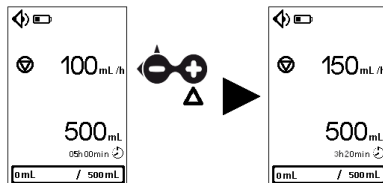

Press **+** or **-** key to set the feeding rate.

- Adjust target volume (mL)

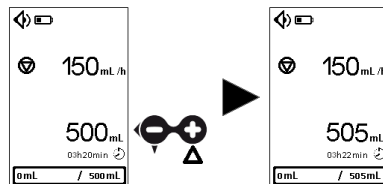

Press **+** or **-** key to set the target volume.

INFORMATION



In bolus mode, the target volume is adjusted per bolus.

- Solve incompatible values (for bolus feeding)

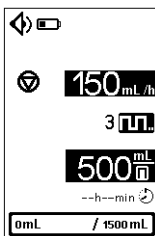

If the feeding is impossible due to incompatible values with the Bolus parameters programming (Flow rate and Volume values are not possible with the time interval between boluses programmed in the bolus menu):

- The bolus volume and the flow rate are blinking
- The start key is inactive and the forbidden key beep is triggered
- The remaining time is not displayed

In homecare, prescription values can be confirmed by calling healthcare provider or healthcare professional.

Modify bolus feeding parameters. To modify bolus settings, see *Bolus mode settings* on page 35.

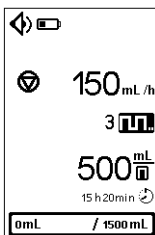

When the setting is OK for running with the correct values according to the prescription:

- Start key is functional
- Remaining time is displayed
- Feeding can be started



WARNING

Make sure feeding parameters are checked before starting feeding (programming error can lead to overfeeding, underfeeding or delay of therapy).

4.2.5 Start feeding

1. Connect the giving set to the patient's enteral feeding tube. Ensure that the giving set is not stuck in any way.
2. Make sure that priming is correctly completed before starting feeding.

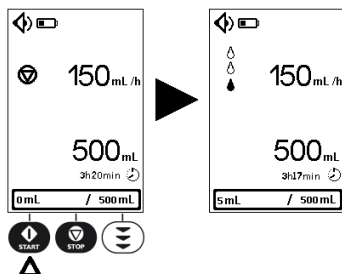

3. Check power supply before starting feeding.
 - Green light indicator if supplied by mains, or
 - Battery icon filled up if supplied by the battery.

Keypad lock is recommended for bolus feeding in order to avoid misuse.

4.2.6 Terminate feeding

- Stop feeding

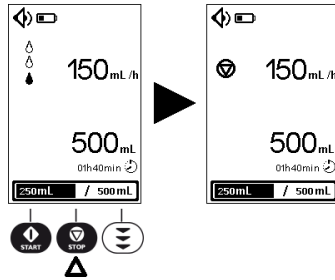

When feeding is stopped, flow rate and target volume parameters can be adjusted. Then, feeding can resume.

- Reset the progress bar.

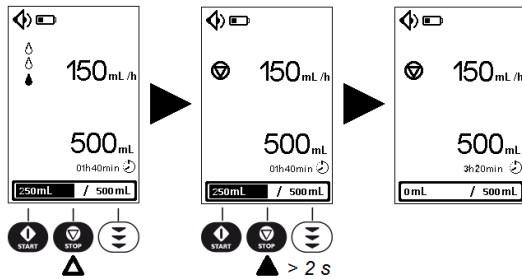

When the pump is stopped, progress bar can be reset by depressing the  key for 2 seconds.

4.2.7 Switch off pump

Feeding shall be stopped before switching off the pump.

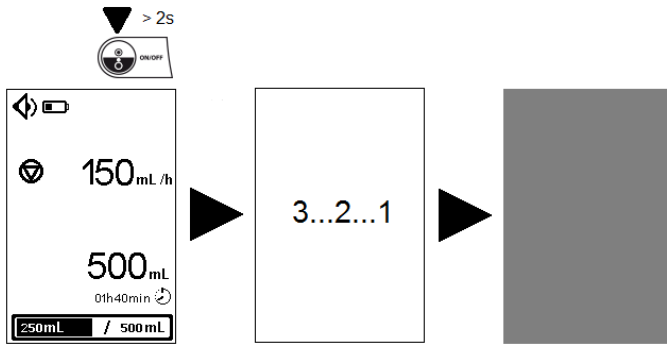

INFORMATION

- When feeding is on-going, the  key is inactive: the forbidden key beep is triggered but feeding continues.
- When switched off, the pump retains the following information:
 - flow rate, volume and progress bar on the setting screen;
 - cumulative feeding volume;
 - bolus settings;
 - remaining time;
 - target volume mode;
 - sound level, key beep activation / deactivation;
 - contrast and brightness;
 - feeding and Alarm history;
 - settings lock activation / deactivation;
 - time between 2 alarm sounds;
 - time for target volume almost reached message;
 - technical information.
- This information is saved even if the battery is disconnected with no time limit.
- Feeding history and Alarm history allow the record of the 250 latest events for each history.
- In the case of a powering down, the time of powering down is not retained in the history.

4.2.8 Removing/Changing the giving set from the pump

The mechanical properties of the administration set in association with the pump are designed to maintain pumping performance for a maximum of 5 L or a 24-hour period.

Replace the administration set according to your healthcare facility's protocol or CDC guidelines.

Administration sets are supplied sterile and are indicated for single use.

WARNING



- The use of the same set for more than 24 hours can lead to therapeutic issues, such as infection, and uncontrolled flow.
- For patients requiring special attention, another giving set must always be available.

1. Push up the lever to unlock the door **1**.
2. Open the door **2**.
3. Remove giving set **3**.

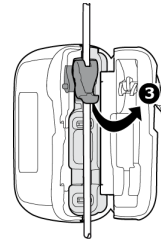
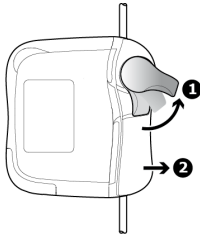



Install a new giving set in the pump (see *Installing the giving set* on page 22).

4.2.9 Keypad lock

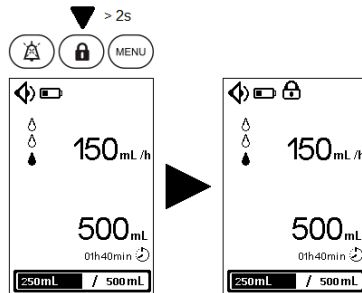
Keypad lock prevents from unintentional tampering of pump settings.



When keypad is locked:

-  is displayed in the status bar;
-  is the only active key. If other keys are depressed, the forbidden key beep (2 beeps) is triggered, no action is undertaken and feeding continues.

Keypad can be unlocked by depressing the keypad lock key  for 2 seconds.

Unlocking the keypad is required to stop feeding, change feeding settings and enter the menu.

4.2.10 Mute alarm

To temporarily release alarm sound, press .

When a medium priority alarm is muted:

- the mute icon  is displayed in the status bar;
- the alarm symbol is displayed and the yellow LED keeps flashing until a corrective action is performed;
- the alarm sound is off for 2 minutes.

When a low priority alarm is muted:





- the mute icon  is displayed in the status bar;
- the alarm symbol is displayed and the yellow LED is lit;
- the alarm sound is off and an information signal sound (2 beeps) is emitted every 30 minutes.

For further information about alarms, see *Alarms / Actions* on page 49.

5 Pump menu

INFORMATION



- The menu is accessible when feeding is stopped.
- A beep sound is triggered when a forbidden key (not active in specific screens) is depressed.
- During a procedure, press  () to validate the choice and go back to the setting screen.
- Press  () to go back to the previous screen (without validation).

5.1 Access menus

Menu descriptions

Menus	Description
Select feeding mode and settings	Continuous mode activated: Deactivate / activate target volume mode (the access code is required, if the settings lock is activated)
	Bolus mode activated: Deactivate / activate flushing information Enter the bolus settings (number of bolus, time interval between boluses) (the access code is required, if the settings lock is activated)
Night mode	Night mode activation / deactivation
Sound	Adjust sound level
	Deactivate / activate key beep
Settings lock	Deactivate / activate settings lock
Cumulative feeding volume counter	Display cumulative feeding volume
	Clear cumulative feeding volume
Alarm history	Consult the last 250 alarm events
Feeding history	Consult the last 250 feeding events
Contrast / Brightness	Contrast setting
	Brightness setting
Time between 2 alarm sounds	Consult time between 2 alarm sounds
	Set time between 2 alarm sounds (the access code is required)

Menus	Description
Time for target volume almost reached message	Consult time for target volume almost reached message
	Set time for target volume almost reached message (the access code is required)
Technical information	Consult technical information of the pump
Reset manufacturing setting	Set pump to factory settings

Menu navigation

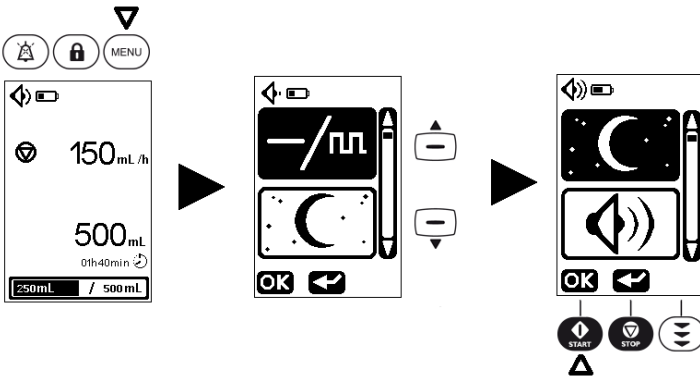

Press then press to scroll up / down between submenus.

Press to enter the submenu.



5.2 Feeding mode and settings

5.2.1 Feeding mode selection

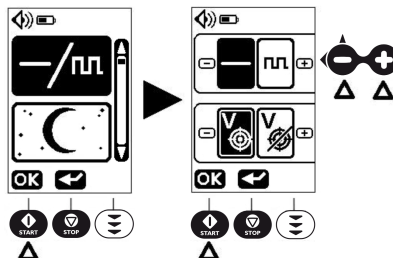
On this screen, continuous mode is activated .







Press  to select Feeding mode and settings.

Press  to activate Continuous mode or  to activate Bolus mode.

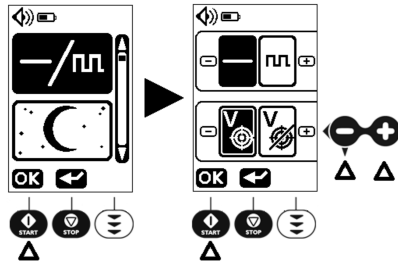
5.2.2 Continuous mode settings

On this screen, target volume mode is activated . If you programme a feeding with no target volume and a feeding with target volume with respectively different flow rates, the respective flow rates are saved.





Press  to select target volume mode in the menu. Press  or  to deactivate / activate target volume mode (default setting: activated). Press  to validate.

INFORMATION



- When target volume mode is deactivated, the target volume and the progress bar disappear from the display.
- If the settings lock is activated, the access code is required to activate / deactivate target volume.

5.2.3 Bolus mode settings

On this bolus mode menu , flushing information is deactivated .

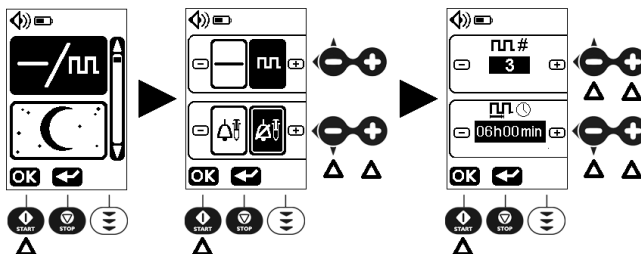

Press the upper **+** to activate Bolus mode in feeding mode menu. Press **+** or **-** to deactivate / activate flushing information (default setting: deactivated). Press **START** to validate.

Press **-** or **+** to set the bolus number.



INFORMATION

The bolus number is adjustable from 1 to 24. If ∞ is selected, the pump performs boluses until the replacement of the container. In this case, if the pump is switched off during a bolus, the complete volume of bolus will be delivered when starting feeding again.

Press **-** or **+** to set the time interval between boluses. Press **START** to validate.

5.3 Night mode

On this screen, night mode is activated

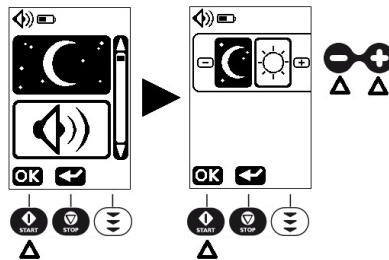



Press **START** to select Night or Day Mode. Press **+** to activate Day Mode or **-** to activate Night Mode. Press **START** to validate Night or Day Mode.





INFORMATION



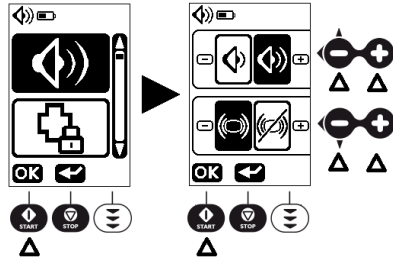

- When night mode is activated, display backlight and power LED are set to minimum level.
- In case of alarm, the backlight turns back to normal.
- Night mode is automatically deactivated after switching OFF the pump.

5.4 Sound

The pump is set by default to the highest sound level . It can be reduced to a lower sound level .



Press  to select the sound level and key beep sound.

Press  /  to select low or high sound level. Press  to deactivate key beep or press  to activate key beep.

Press  to validate the sound level and key beep sound ON or OFF (default setting ON).





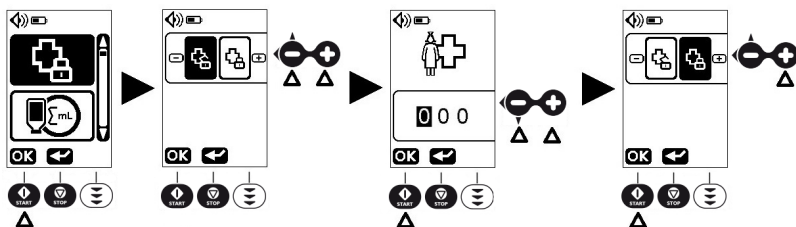

WARNING

Audible alarm signal level is adjustable. However, please ensure the user can hear alarms, especially when the pump is used on battery.

5.5 Settings lock



Press  key to configure Settings lock. Press  key to enter the access code.

Enter the access code by adjusting each digit (0 to 9) using  and  keys and validate each digit by pressing . If you enter the wrong code, it is reset to 0 0 0.

Press  to activate settings lock function.

When settings lock is activated:

-  is displayed in the status bar;
- target volume and flow rate cannot be changed;
- Accessible keys are:



INFORMATION





- To get the access code, contact your Fresenius Kabi sales representative.
- Settings lock activation / deactivation isn't modified after switching OFF the pump.
- When settings lock is activated, keypad lock can still be activated / deactivated.

5.6 Cumulative feeding volume counter

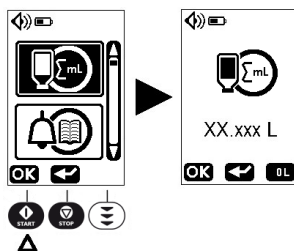
Press  to display the cumulative feeding volume. The total feeding volume since last reset is displayed.



If needed, press  then  to clear the cumulative feeding volume (default setting).

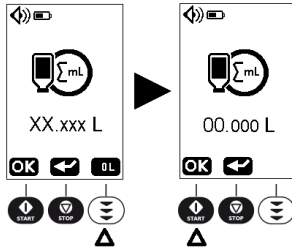

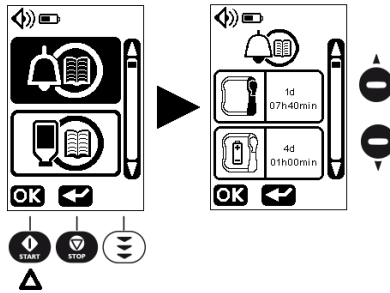

5.7 Alarm history

Alarm events are automatically saved in the pump memory.



Press  to display the alarm events.

Press  ,  to switch from one alarm event to another.

INFORMATION

Alarm history indicates the type of alarm and the time elapsed since the event happened.

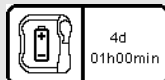

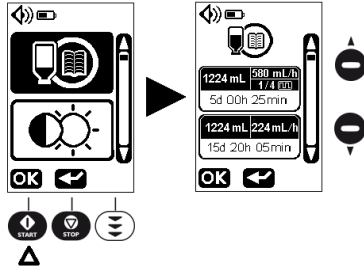

Example: a battery alarm occurred 4 days, 1 hour and 0 minute ago.

5.8 Feeding history



Press  to display the feeding events.

Press ,  to switch from one feeding event to another.

INFORMATION



Feeding history indicates the delivered volumes, their associated flow rate and the time elapsed since their delivery.

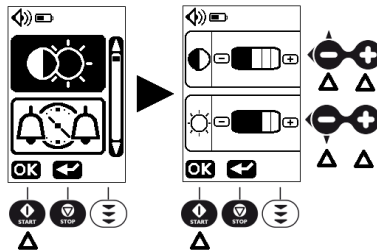

Example: a volume of 1224 mL was administered at a flow rate of 580 mL/h split on 4 boluses, 5 days and 25 minutes ago.

5.9 Contrast / Brightness



Press . Press  to set the contrast or the brightness.

Press  to validate.

5.10 Set time between two alarm sounds

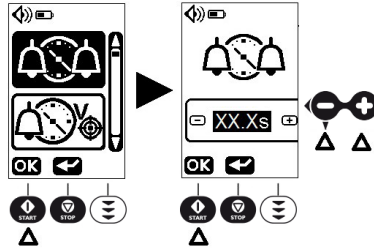

Press . Press or to set the time between two alarm sounds. Press to validate.



INFORMATION

The access code is required to set time between two alarm sounds.



WARNING

Time between 2 alarms can be adjusted from 2.5 to 30 seconds with steps of 0.5 seconds. This adjustment can modify the perception of an alarm (Default value 2.5 seconds).

5.11 Set time for target volume almost reached message

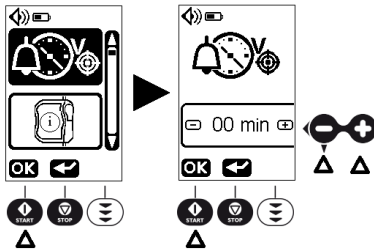

Press . Press or to set the time for target volume almost reached message.

Press to validate.



INFORMATION





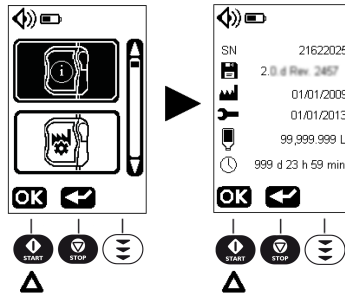

- Time between target volume almost reached message and target volume reached alarm can be adjusted from 0 to 59 min., with steps of 1 min (default setting 5 min.).
- Access code is required to set time for target volume almost reached message.

5.12 Technical information



Press  to access the technical information.

NOTE: the technical information menu displays:

-  Pump serial number
-  Software version
-  Production date (mm/dd/yyyy)
-  Last maintenance date (mm/dd/yyyy)
-  Total delivered volume
-  Total functioning time

5.13 Reset manufacturing settings

Reset manufacturing settings is recommended to facilitate the transition from one patient to another.

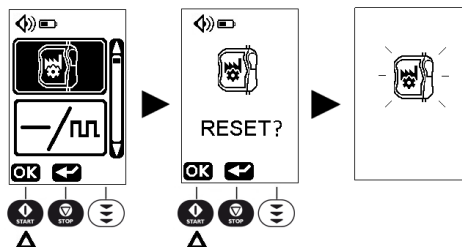

Press  to access the reset menu.

Press  again to reset to manufactory settings. The Reset symbol is flashing for 2 seconds.

- All prior settings are erased

- All pump settings revert back to factory settings



INFORMATION

The access code is required to reset manufacturing settings.

6 Cleaning and disinfection

6.1 Prohibited cleaning or disinfection agents

Do not use cleaning or disinfection agents that contain the following substances as these aggressive agents may damage the plastic parts of the device and cause the device to malfunction:

- trichloroethylene
- abrasive detergents

6.2 Precautions

Clean pump and pump holder as soon as they become contaminated with tube feed or drugs, and at least once a week.

After cleaning, the pump should be left to dry for approximately 5 minutes before being started or reconnected to the mains.

The pump must be cleaned after each patient usage by a trained nurse or assistant nurse.

WARNING



- The pump is not intended to be sterilized, it may damage the pump. The Amika+ is a non-sterile medical device.
- The Amika backpack must be cleaned before inserting the pump. Please refer to its specific accompanying documents.
- Make sure to use the original door when replacing it on the pump (check the serial number on the pump is the same as on the door). A door switch between pumps can lead to major pumping errors.

6.3 Recommended cleaning and disinfection agents

Didecyldimethylammonium chloride (example: Wip'Anios Excel by Anios).

Please contact the appropriate service, responsible for cleaning and disinfection products in your establishment for further details.

6.4 Cleaning and disinfection guidelines and protocol

INFORMATION



- Do not immerse pump and pump holder in liquids or let liquids enter device's housing. 
- Pump and pump holder are resistant to recommended cleaning agents (see *Recommended cleaning and disinfection agents* on page 44).

6.4.1 Cleaning Instructions

Prerequisites

- The pump is switched off.
- The power cord and all other cables are unplugged.
- The pump is disconnected from the holder.
- The air is at room temperature (20 to 25 °C).
- The operator is wearing suitable protective equipment.

Protocol

1. Place the pump and the holder on a cleaned surface or disposable underlay. The door can be removed from the pump to facilitate the cleaning.



NOTE: The door can be immersed. Clean it separately with running water.

2. During cleaning, do not turn the pump over to avoid liquid leak in the battery door.
3. Use a ready-to-use wipe to remove any major grime.
4. Thoroughly wipe down all exposed surfaces (housing, keypad, screw area, holder connection area, etc.) of the pump, from top to bottom. Gently wipe down the pump exposed mechanism and sensor area (tube guide, purple insert).

A minimum cleaning of 1 minute is recommended (allow to remain visibly wet for 1 minute), until all organic matter is dissolved and removed. Do not allow liquids to run, leak, or drip into the pump housing. Use cotton wool to clean the contact pens.

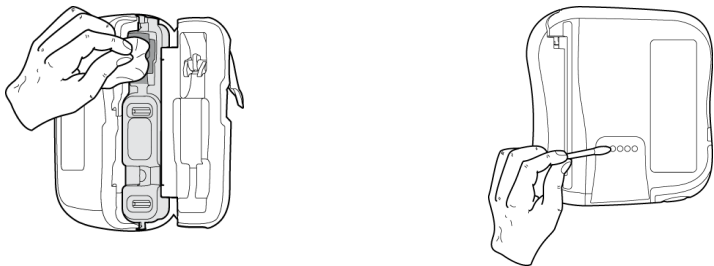

5. Repeat step 4 with the pump door (housing, lever, counter door) and holder (pole clamp screw, housing, etc.)
6. Using a fresh ready-to-use wipe, thoroughly wipe down all exposed surfaces. A minimum cleaning of 1 minute is recommended (allow to remain visibly wet for 1 minute), until all organic matter is dissolved and removed.
7. Wipe down the power cord.
8. Allow the device to dry completely at room temperature.

9. Make sure to use the original door when replacing it on the pump (check the serial number on the pump is the same as on the door).

6.4.2 Disinfection instructions

Prerequisites

- The cleaning protocol has been performed.
- The pump is switched off.
- The power cord and all other cables are unplugged.
- The pump is disconnected from the holder.
- The air is at room temperature (20 to 25 °C).
- The operator is wearing suitable protective equipment.

Protocol

1. Place the previously cleaned pump and holder on a cleaned surface or disposable underlay. The door can be removed from the pump to facilitate the disinfection.
2. During disinfection, do not turn the pump over to avoid liquid leak in the battery door.
3. Use a ready-to-use wipe to wipe down all exposed surfaces of the pump, holder and pump door (as described in cleaning protocol), making sure to cover all cracks, crevices, and hard-to-reach areas. Do not allow liquids to run, leak, or drip into the pump housing.
4. Using a fresh ready-to-use wipe, repeat steps 3. Ensure that the minimum contact time for each step is 3 minutes for bactericide activity (surface remain visibly wet for 3 minutes). Respect the indicated contact time from the manufacturer recommendations for the required antimicrobial activity.
5. Wipe down the power cord.
6. Allow the pump to dry completely at room temperature.
7. Make sure to use the original door when replacing it on the pump (check the serial number on the pump is the same as on the door).

7 Quick check protocol



WARNING

- The following checks allow users to confirm device behaviour according to these instructions for use. Fresenius Kabi recommends performing these tests before connecting Amika+ pump to patients.
- If one or more checks do not comply with the right pump behaviour, please contact the appropriate department or Fresenius Kabi sales representative for additional verification.

Action	Yes
Before use	
1 - Check if the Amika+ pump, holder and power cable are not damaged in any way	<input type="checkbox"/>
2 - Check the general status of the display	<input type="checkbox"/>
3 - Install the Amika+ pump on the holder	<input type="checkbox"/>
4 - Connect holder to the mains	<input type="checkbox"/>
5 - Switch on the pump	<input type="checkbox"/>
6 - Check the autotest sequence (LCD display intact, speaker, LED and the back light). Do not use with damaged screens.	<input type="checkbox"/>
7 - Check the mains LED lights up	<input type="checkbox"/>
8 - Remove the Amika+ from the holder and check the battery symbol on the display	<input type="checkbox"/>
9 - Install the Amika+ pump on the holder	<input type="checkbox"/>
10 - Check that the pump and its holder are securely attached or positioned	<input type="checkbox"/>
11 - Check that all menu settings are adapted to the next patient	<input type="checkbox"/>
12 - Connect a set to a filled container, install the set in the pump and close the door	<input type="checkbox"/>
13 - Prime the set	<input type="checkbox"/>
14 - Set at the prescribed flow rate and target volume	<input type="checkbox"/>
15 - Start feeding	<input type="checkbox"/>
16 - Check the feeding information (droplet animation)	<input type="checkbox"/>
17 - Check that pumping is effective	<input type="checkbox"/>
After use	
1 - Check if pump, holder and power cable are not damaged in any way	<input type="checkbox"/>
2 - Clean the pump, holder and power cable	<input type="checkbox"/>

Action	Yes
3 - Check the membrane of Amika+ pump is intact (no cracks, no wear)	<input type="checkbox"/>
Once a year	
Check the following alarms and messages (symbol on the display, beep sound, blinking status light indicator)	
1 - Set installation alarm	<input type="checkbox"/>
2 - Door alarm	<input type="checkbox"/>
3 - Upstream occlusion alarm	<input type="checkbox"/>
4 - Downstream occlusion alarm	<input type="checkbox"/>
5 - Empty bag / Air in Line alarm	<input type="checkbox"/>
6 - Target volume almost reached message	<input type="checkbox"/>
7 - Battery nearly empty message	<input type="checkbox"/>
8 - Check the flow rate by measuring the delivered volume	<input type="checkbox"/>

8 Alarms and safety features

8.1 Alarms / Actions

The Amika+ pump has a continuous inspection system that operates as soon as it is in use. It is recommended that the user should be in front of the Amika+ pump, for best visibility of alarm display.

Please make sure the appropriate reaction to alarm is undertaken. A wrong or delayed reaction leads to a delay in therapy.



WARNING

The pump emits audible alarm signals. Audible alarm signals from medical devices may be masked by environmental noise. Ensure the alarm sound level is audible by the user, taking into account the environment.



The alarm sound level measures are:

	Settings	Pump on its holder	Pump inside a backpack
High, medium, low priority alarms	Low Level	> 50 dB(A)	> 45 dB(A)
	High Level	> 60 dB(A)	> 50 dB(A)



NOTE: dB(A) is the Level average pressure measured following ISO 3744

8.1.1 The different types of information signal or alarm

Information signal sound (2 beeps)		Information signal	Feeding continues
Information signal sound (1 beep)		Information signal	Feeding continues
Flashing yellow LED and alarm sound (sequences of 2 beeps)		Information signal	Feeding continues
Fixed yellow LED and alarm sound (sequences of 3 beeps).		Prior information to alarm (Low priority alarm)	Feeding continues
Flashing yellow LED and alarm sound (sequences of 3 beeps)		Functional alarm (Medium priority alarm)	Feeding stops

Flashing red LED and alarm sound (sequences of 10 beeps)		Technical alarm (High priority alarm)	Feeding stops
Flashing red LED and buzzer sound		Fail safe technical alarm (High priority alarm)	Feeding stops

When a functional alarm or prior information to alarm occurs:

- to mute alarm sound, press , see *Mute alarm* on page 32;
- detect the specific problem causing the alarm or prior information to alarm condition, by looking at the drawing displayed on the pump;
- to release alarm, press ;
- make a corrective action (see table below);
- restart feeding using the  key.

 **WARNING**
Identify displays, symbols and status in the table below, to understand the meaning and conduct the appropriate action.

8.1.2 Alarm descriptions

Line control

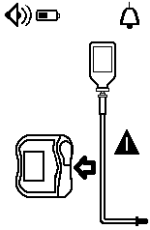

Symbol	Meanings	Actions
Medium priority - Yellow LEDs are flashing		
Giving set 	Missing giving set or giving set not properly installed or wrong set installed.	<ul style="list-style-type: none"> ■ Check position of giving set above and below the pump mechanism and insert correctly if necessary. ■ Check that the proper set is used (Amika+ giving sets only). <input type="checkbox"/> See <i>Installing the giving set</i> on page 22.
	Area where pinch clamp is inserted is contaminated.	<ul style="list-style-type: none"> ■ Remove dirt with cloth and soapy water or as directed by hospital policy. ■ Allow the pump to dry. <input type="checkbox"/> See <i>Disinfection instructions</i> on page 46.

Symbol	Meanings	Actions
<p>Door open</p>	Pump door not properly closed at start.	<ul style="list-style-type: none"> ■ Close pump door. □ See <i>Installing the giving set</i> on page 22.
	Pump door opened after start.	<ul style="list-style-type: none"> ■ Close pump door. □ See <i>Installing the giving set</i> on page 22.
	Pump door removed from its anchoring.	<ul style="list-style-type: none"> ■ Re-hang door.
	Door mechanism is faulty.	<ul style="list-style-type: none"> ■ Contact your biomedical department.
<p>Upstream occlusion</p>	Upstream flowpath is blocked between the container and the pump.	<ul style="list-style-type: none"> ■ Open the door, check set installation. □ See <i>Installing the giving set</i> on page 22. ■ Check that the set is not kinked. ■ Check that upstream clamp is open. ■ Flush tube if necessary. ■ Check the absence of upstream / downstream occlusion in the line.
<p>Downstream occlusion</p>	Downstream flowpath is blocked after the pump, at the patient side.	<ul style="list-style-type: none"> ■ Open the door, check the set installation, close the door. □ See <i>Installing the giving set</i> on page 22. ■ Check that the set is not kinked. ■ Re-position and verify that food flows freely after adjustment. ■ Check that the feeding tube is clear. ■ Flush tube if necessary. ■ Check the absence of upstream / downstream occlusion in the line.

Feeding control

Symbol	Meanings	Actions
--------	----------	---------

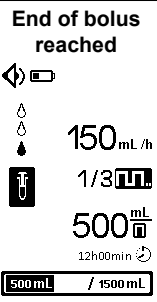
Low priority - Yellow LEDs are fixed

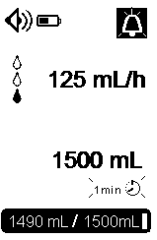

Symbol	Meanings	Actions
<p>End of bolus reached</p> 	<p>Displayed in feeding bolus mode only if the flushing information is activated. The flushing information will be displayed at the end of the pumping period of a bolus (except the last bolus).</p>	<p>The flushing information can be activated/deactivated in the menu.</p> <ul style="list-style-type: none"> <input type="checkbox"/> See <i>Bolus mode settings</i> on page 35. ■ To clear the flushing information, press .
<p>Target volume almost reached</p> 	<p>Target volume will be reached. Remaining time is flashing.</p>	<p>The time of message before target volume is reached can be set in the menu.</p> <ul style="list-style-type: none"> <input type="checkbox"/> See <i>Set time for target volume almost reached message</i> on page 41. ■ End feeding or continue feeding.

Medium priority - Yellow LEDs are flashing

<p>Target volume reached</p> 	<p>Alarm The target volume is reached. (Complete progress bar)</p>	<ul style="list-style-type: none"> ■ End feeding or proceed to the next step.
---	---	--

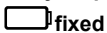
Function control



Symbol	Meanings	Actions
Low priority - Symbol battery is fixed yellow		
<p>Battery empty</p> 	<p>Minimum battery voltage is not available.</p>	<p>This message appears 30 min. before the empty battery alarm.</p> <ul style="list-style-type: none"> ■ Connect the pump to the mains via the pump holder. Recharge battery to resume pump operation.
Medium priority - Symbol battery is flashing yellow		

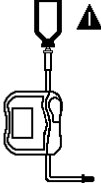

Symbol	Meanings	Actions
<p>Battery empty</p>   <p>flashing</p>	<p>Alarm medium Minimum battery voltage is not available.</p>	<p>This alarm appears 10 min. before battery is fully discharged.</p> <ul style="list-style-type: none"> Connect the pump to the mains via the pump holder. Recharge battery to resume pump operation.

Medium priority - Yellow LEDs are flashing

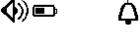
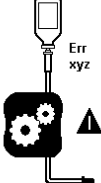

<p>Empty bag / Air in line</p>  	<p>Feed container is empty.</p>	<ul style="list-style-type: none"> End feeding or connect to a filled feed container.
	<p>Air is in the giving set.</p>	<ul style="list-style-type: none"> Fill giving set to the end. See <i>Priming the giving set</i> on page 25.
	<p>Dirt in sensor area (lower tube guide).</p>	<ul style="list-style-type: none"> Open the door and remove dirt with cloth and soapy water or as directed by hospital policy (see <i>Cleaning and disinfection</i> on page 44). Allow the pump to dry.
	<p>Giving set not properly connected to the container.</p>	<ul style="list-style-type: none"> Check position of giving set and insert correctly if necessary. See <i>Installing the giving set</i> on page 22.

High priority - Red LEDs are flashing - Alarm sound

<p>Technical alarm</p>  	<p>A technical alarm code is displayed with the "Pump error alarm" drawing.</p>	<ul style="list-style-type: none"> Note the technical Error code (Err xyz). To release technical alarms, press  or  for 2 seconds. The pump will then switch off instantly (no count-down). Contact your biomedical department.
---	---	--

Symbol	Meanings	Actions
Battery technical alarm   Err xyz  OK	The last battery technical alarm that occurred before switch OFF is reminded at the next switch ON.	<ul style="list-style-type: none"> Note the technical Error code (Err xyz). Contact your biomedical department.
Fail safe technical alarm	Pump stops immediately.	<ul style="list-style-type: none"> Contact your biomedical department.

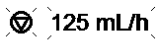
Information signal - Yellow LEDs are flashing

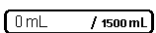
Start reminder    	Pump is switched on but not operating for 2 minutes (2 beeps)	<ul style="list-style-type: none"> Proceed to next step or switch pump off.
---	---	--

NOTE: The maximum volume infused between the alarm condition and the technical alarms generation is 35 mL.

8.1.3 Maximum alarm raising delay

Time between alarm condition and alarm generation is less than 5 seconds, except for Giving set, Upstream and Downstream occlusions and Empty bag / Air in Line alarms (see *Performance* on page 56).



INFORMATION

When two alarms are raised at the same time, the pump software prioritizes the alarms.

8.2 Troubleshooting

Issue description	Recommended action
Pump is not stable when mounted	<ul style="list-style-type: none"> Check that the clamp handle is fastened

Issue description	Recommended action
Pump or holder is damaged, noisy, smoking or with an abnormally hot part. Pump screen is damaged	<ul style="list-style-type: none"> ■ Remove power cable ■ Do not use the device ■ Contact your biomedical department or Fresenius Kabi sales representative immediately
Pump has been dropped	<ul style="list-style-type: none"> ■ Do not use the device ■ Contact your biomedical department or Fresenius Kabi sales representative
Pump does not start after switched ON	<ul style="list-style-type: none"> ■ Connect pump to the mains supply in case the battery is fully discharged ■ Contact your biomedical department or Fresenius Kabi sales representative if problem remains
Flow rate variance is higher than flow rate accuracy	<ul style="list-style-type: none"> ■ Check giving set configuration ■ Check fluid viscosity ■ Check the fluid is within normal temperature conditions ■ Contact your biomedical department or Fresenius Kabi sales representative if problem remains
Front panel problem (keys, LEDs)	<ul style="list-style-type: none"> ■ Check the general state of the front panel (keypad) ■ Check the contrast ■ Contact your biomedical department or Fresenius Kabi sales representative if problem remains
The mains connection LED does not light up	<ul style="list-style-type: none"> ■ Connect pump to the mains supply ■ Check that the LED on the front panel of the pump holder lights. If not, unplug and plug it again in the mains socket. ■ Contact your biomedical department or Fresenius Kabi sales representative if problem remains
The device switches off on its own	<ul style="list-style-type: none"> ■ Connect pump to the mains supply ■ Contact your biomedical department or Fresenius Kabi sales representative if problem remains
Battery alarm when pump has been correctly charged	<ul style="list-style-type: none"> ■ Check mains supply voltage ■ Contact your biomedical department or Fresenius Kabi sales representative if problem remains
The device switches off when it is disconnected from the mains	<ul style="list-style-type: none"> ■ Battery is completely discharged: Charge the battery ■ Contact your biomedical department or Fresenius Kabi sales representative if problem remains
Bolus volume and flow rate are blinking and feeding can not start in bolus mode.	<ul style="list-style-type: none"> ■ Check bolus feeding parameters, see <i>Feeding mode and settings</i> on page 34.
The Nurse Call system does not replicate pump alarms. RS232 serial communication connector is not functional.	<ul style="list-style-type: none"> ■ Check Nurse Call cable installation ■ Check holder is connected to the power supply ■ Contact your biomedical department or Fresenius Kabi sales representative if problem remains.

9 Technical information

9.1 Performance

9.1.1 Essential performance

Essential pump performance is defined as follows in standard operating conditions:

- flow rate accuracy ($\pm 5\%$ at 125 mL/h*);
- occlusion detection time (< 6 min at 50 mL/h with medical water);
- management of medium and high priority alarms, see *The different types of information signal or alarm* on page 49.



WARNING

Flow rate accuracy can be influenced by giving set configuration, tube stretching, fluid viscosity, fluid temperature, container height and feeding settings.

9.1.2 Flow Rate range

Range	From 1 mL/h to 600 mL/h (default setting 50 mL/h)
Increments	1 mL/h from 1 mL/h to 600 mL/h
Accuracy	$\pm 5\%$ at 125 mL/h* $\pm 10\%$ for the whole range of flow rates

Test initial conditions following 60601-2-24. Cumulative volume measured on a two-hour period, with 25 mL minimum volume and medical water. * Probability higher than 80%.

Container height: 50 cm.

9.1.3 Volume range

Range	From 1 mL to 5000 mL (default setting 500 mL)
Increments	1 mL from 1 mL to 5000 mL

9.1.4 Upstream and downstream occlusions

Occlusion alarm response time at different flow rates.

Threshold available for triggering downstream occlusion alarm:

- Occlusion will be detected for pressure 787.6 mmHg, ± 262.5 mmHg.

Occlusion detection time		
Flow rate	Downstream occlusion (1 m after the pump)	Upstream occlusion (5 cm before the pump)
1 mL/h	5 hours	1 hour 40 min.
25 mL/h	9 min.	4 min.

NOTE: Maximum occlusion pressure for the pump is 1875 mmHg, \pm 200 mmHg.

9.1.5 Volume Accuracy

	Accuracy	
Limit to detect Upstream Occlusion*	\leq 25 mL	
Bolus volume at Occlusion Release*	Rate 25 mL/h	< 5 mL

*Test condition: Back pressure: 0 mmHg, Container height: 50 cm

NOTE: A bolus (\pm 5mL) may occur during pump movement from 0 to 1 m above the patient, and before occlusion release.

9.1.6 Empty bag / Air in Line alarm response time at different flow rates

Time mentioned is applicable only if the set has been previously filled.

Empty bag / Air in Line detection time	
Flow rate	Air volume = 3.5 mL
1 mL/h	3 hours 30 min. maximum
25 mL/h	10 min. maximum
100 mL/h	3 min. maximum

9.1.7 Giving set alarm response time at different flow rates

Flow rate	Giving set alarm detection time
1 mL/h	8 minutes maximum
25 mL/h	30 seconds maximum
100 mL/h	10 seconds maximum

9.2 Technical characteristics

9.2.1 Operation mode

The Amika+ pump is a reusable device. The pump ensures fluid delivery in a continuous and sequential feeding mode, using pumping and clamping fingers to push the liquid to the patient.

9.2.2 Power supply specifications

The power cable must be connected directly to the mains power socket.

Protection against electric shocks: class II

Holder input	AC input voltage: 100-240 Vac AC input frequency: 50 / 60 Hz AC input current: 110 mA-205 mA
Holder output	9 Vdc \pm 5 % / 9 W (maximum load)
Power cable length	Approximately 2 m (plug type C)

9.2.3 Battery specifications

Characteristics	NiMH (Nickel-Metal Hydride) 4.8V 2.2 Ah Ni-MH
Weight	Approximately 100 g
Maximum charging time	6 hours

9.2.4 Power consumption

Consumption of the pump in standard operating conditions: maximum 9 W.

9.2.5 RS232 serial communication connector specifications

Input/output	RS232 signal
Electrical insulation	1.5 kV insulation.
Compliance with standard	IEC/EN 60601-1 (leakage current)

	<p>WARNING</p> <p>This connector is for data communication and maintenance use only. Improper use of the RS232 serial communication connector may cause the impossibility to perform maintenance or data communication.</p>
--	--

9.2.6 Nurse call connector specifications

Holder output	24 Vdc SELV (Safety Extra Low Voltage) / 0.5 A maximum 24 Vac / 0.5 A maximum
Electrical insulation	1.5 kV insulation

9.2.7 Dimensions - Weight

	Weight	Dimensions (H x W x D)
Pump	610 g	138 x 128 x 48 mm
Smart Holder COM	450 g	Approximately 132 x 118 x 46 mm (without pole clamp)
Power cable	50 g	-

	Weight	Dimensions (H x W x D)
Packaging	500 g	-

9.2.8 Trumpet curves

The trumpet curves show the variations in the mean flow accuracy over specific observation periods. The variations are presented on the maximum and minimum deviations of 5 pumps and 1 pump from the overall mean flow within the observation window.

The test protocol used to obtain these results is described in 60601-2-24.

The curves can be helpful in determining the suitability of feeding parameters for specific nutrition programmes.

Giving set used: Amika Varioline

Fluid used: distilled water, and Fresubin energy drink (1 mL/h only)

9.2.8.1 Minimum flow rate: 1 mL/h

Sampling time: 30 seconds

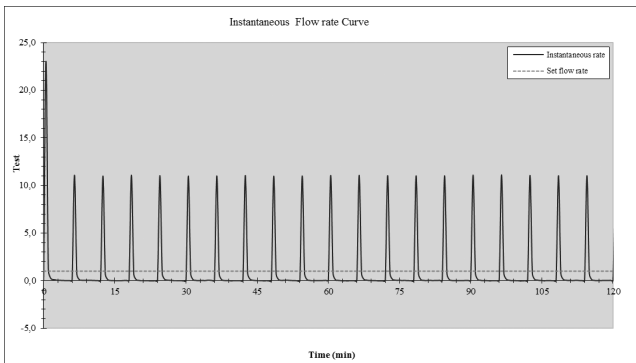

Start up and instantaneous flow rate (1 mL/h, over first 2h of the test period)

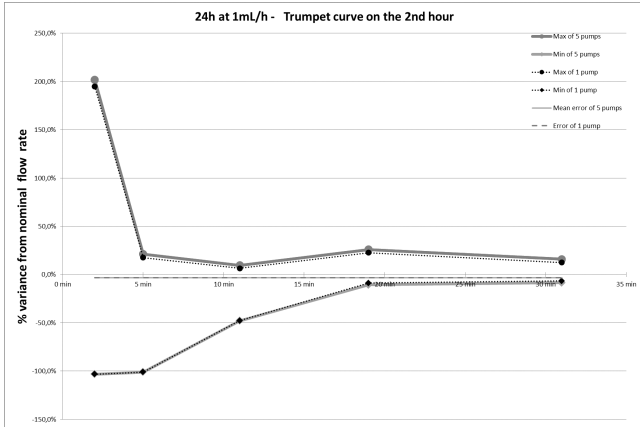

Trumpet curves for 2, 5, 11, 19, 31 minute observation windows (1 ml/h over second hour of the test period)

Sampling time: 30 seconds

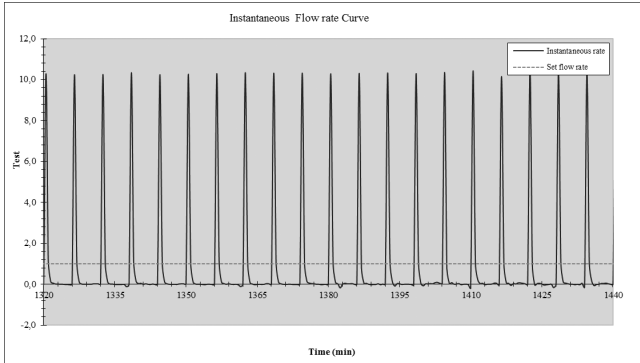

Instantaneous rate (1 mL/h, over last 2 hours of set change interval, 24 hours)

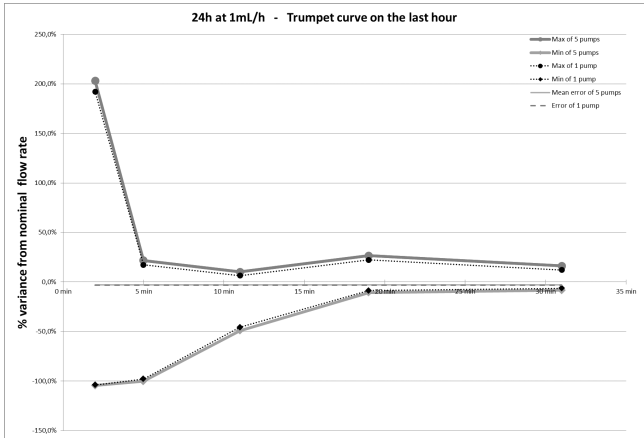

Trumpet curves for 2, 5, 11, 19, 31 minute observation windows (1 mL/h, over last hour of the set change interval, 24 hours)

Sampling time: 15 minutes

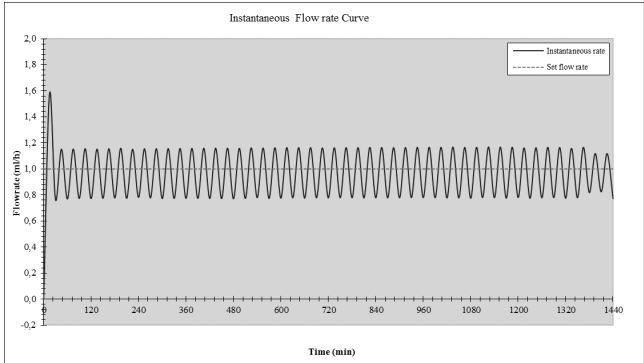

Instantaneous flow rate (1 mL/h, over set change interval 24 hours)

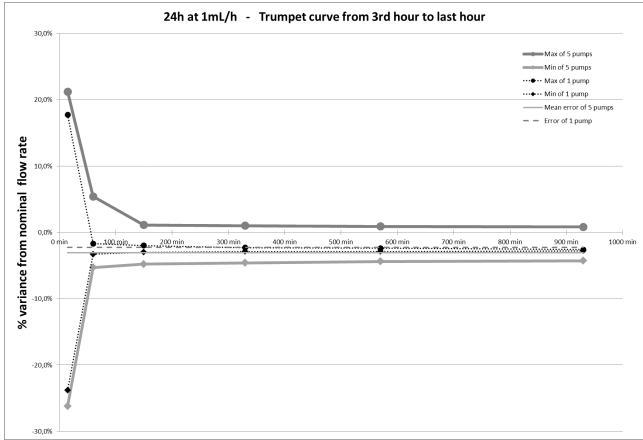

Trumpet curves for 15, 60, 150, 330, 570, 930 minute observation windows (1 mL/h, over set change interval, 24 hours)

9.2.8.2 Intermediate flow rate: 25 mL/h

Sampling time: 30 seconds

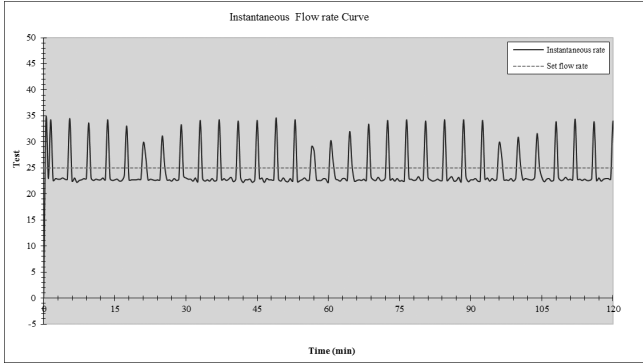

Start up and instantaneous at intermediate flow rate (25 mL/h, over first 2h of the test period)

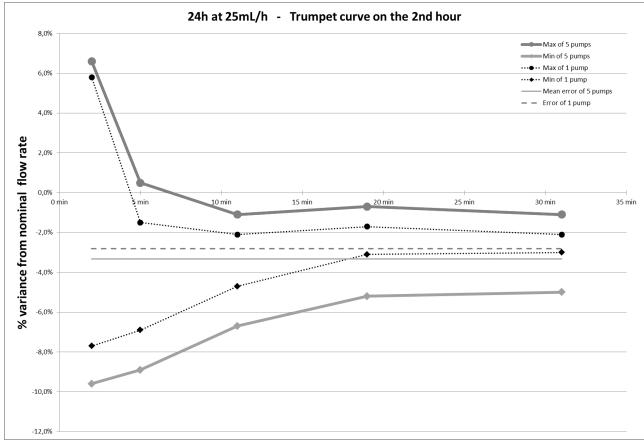

Trumpet curves for 2, 5, 11, 19, 31 minute observation windows (25 mL/h over second hour of the test period)

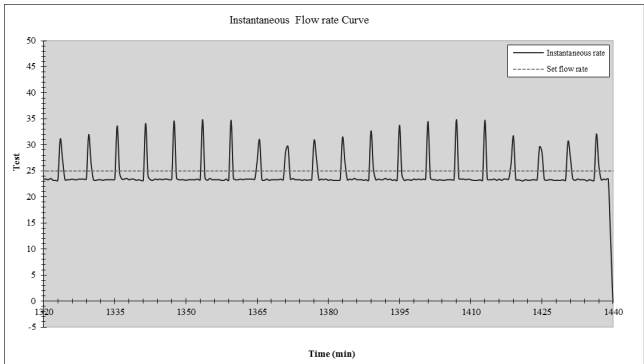

Instantaneous rate (25 mL/h, over last 2 hours of set change interval, 24 hours)

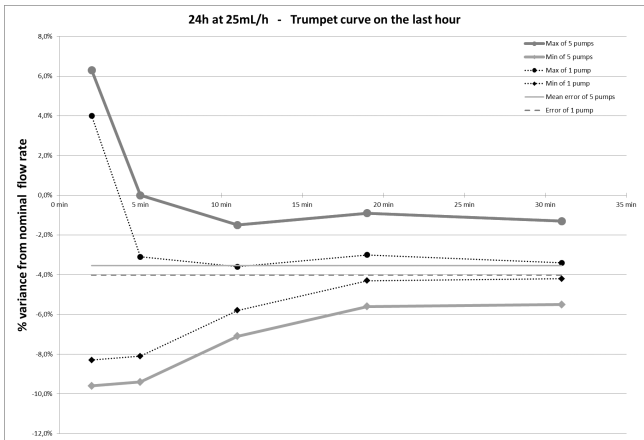

Trumpet curves for 2, 5, 11, 19, 31 minute observation windows (25 mL/h, over last hour of the set change interval, 24 hours)

Sampling time: 15 minutes

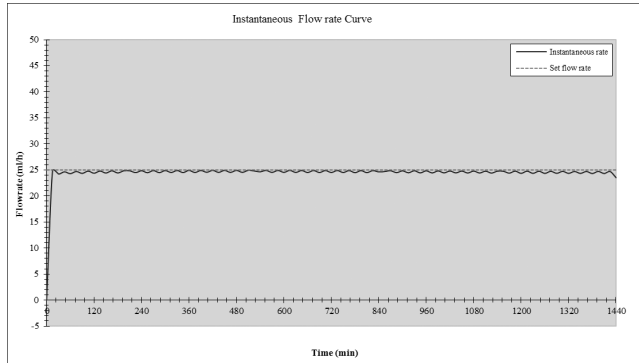

Instantaneous flow rate (25 mL/h, over set change interval 24 hours)

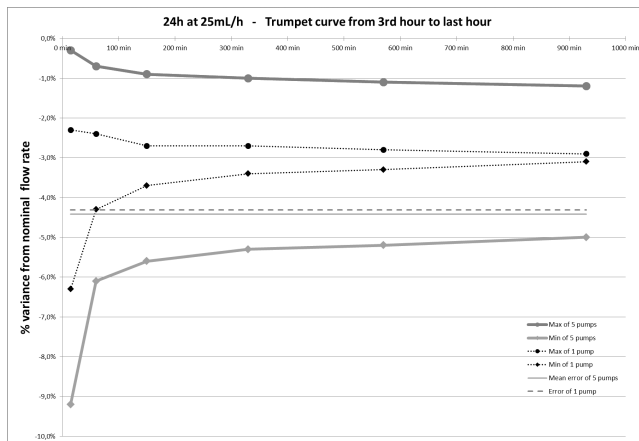

Trumpet curves for 15, 60, 150, 330, 570, 930 minute observation windows (25 mL/h, over set change interval, 24 hours)

9.2.9 Compliance with standards

General requirements for basic safety and essential performance for Medical electrical equipment	Conform to IEC 60601-1
Electromagnetic compatibility- Requirements and tests for Medical electrical equipment	Conform to IEC 60601-1-2
Particular requirements for the basic safety and essential performance of infusion pumps and controllers	Conform to IEC 60601-2-24

General requirements, tests and guidance for alarm systems in medical electrical equipment and medical electrical systems	Conform to IEC 60601-1-8
Requirements for medical electrical equipment and medical electrical systems used in the home healthcare environment	Conform to IEC 60601-1-11
	Conform to the 93/42/EEC Medical directive 0123 : Notified body number (TÜV SÜD Product Service GmbH, Ridlerstrasse. 65, 80339 München, Germany)

NOTE: The full list of applicable standards is available upon request. The device is protected against leakage current and does not disturb ECG or EEG devices.

10 Transport, storage and recycling conditions

10.1 Storage and transport conditions

During transport, the Amika+ pump shall not be removed from its pole or rail when carrying feeding devices, especially when feeding is running.

Check that the power cable is connected and operational after transport of the pump.

The pump should be used under specified storage and transport conditions listed below to ensure pump performance and to avoid pump malfunction.

For further information about storage and transport, see *Use environment* on page 6.

10.2 Storage

Please make sure the pump is stored in an appropriate manner so as to avoid pump malfunctioning.



INFORMATION

- The storage area must be clean, organized and compliant with the storing conditions mentioned above.
- The Amika+ pump must be handled with care during storage.



WARNING

- If the device is not used for longer than 2 months, remove the battery and store it as per storage conditions above.
- If the device is stored without removing the battery, charge it at least once a month by connecting it to the mains for at least 6 hours.
- Amika+ must be cleaned and disinfected prior to storage (see *Cleaning and disinfection* on page 44).

10.2.1 Prepare the device for storage

In order to prepare the device before storage, proceed as specified below:

1. Be sure the pump is not being used on a patient.
2. Switch pump OFF and remove installed giving set (see *Removing/Changing the giving set from the pump* on page 30).
3. Disconnect pump power cord (see *Electrical disconnection* on page 19).
4. Remove the pump and its holder from pole or rails (see *Removing the pump from the pump holder* on page 19).
5. Clean the pump (see *Cleaning and disinfection* on page 44).
6. Handle the pump with care and store it in a compliant area.

10.2.2 Install the device after storage

INFORMATION



- If the battery has been removed for storage, please contact your biomedical department in order to replace the battery into the device prior to using the pump.
- We recommend charging the battery, by leaving the device connected to the mains power supply for at least 6 hours. After prolonged storage, a few minutes may be required before using the pump (an hourglass will be displayed).
- We recommend that the "Amika+ Quick check protocol" is performed when the device is installed after transport, in case of prolonged storage, or before being used on a new patient.

10.3 Recycling and disposal



Before disposal, remove battery from the device. Batteries, accessories and devices with this label must not be disposed of with the general waste. They must be collected separately and disposed of according to local regulations.

For further information regarding waste processing regulations and dismantling, contact your local Fresenius Kabi sales representative.

11 Guidance and manufacturer's declaration on EMC

The Amika+ pump is intended to be used in the electromagnetic environment specified below.

The customer or the user of the Amika+ pump should ensure that it is used in such an environment.

Excluding the cases described in this manual, the pump operation must systematically be checked by a qualified operator, should the pump be installed in the vicinity of other electrical devices.

For further information on EMC compliance, please refer to the Amika+ Technical Manual.

WARNING



- Prolonged exposure to X-ray environments can damage the electronic components of the device and influence the flow rate accuracy. For a safe usage, we recommend to:
 - always put the device at the maximum distance from the patient and the source;
 - limit the presence of the device in such environments.
- In the case of electromagnetic disturbances, if the essential performances, see *Essential performance* on page 56, are lost or degraded, the consequences for the patient can be: overfeeding, underfeeding, delay of therapy, trauma.

11.1 Electromagnetic compatibility and interference guidance

The Amika+ has been tested in accordance with the electromagnetic compatibility standards applicable to medical devices. Its immunity is designed to ensure correct operation. Limitation of the emitted radiation avoids undesirable interference with other equipment.

The Amika+ is classified as a Class B device according to CISPR 11 emitted radiation. The user might be required to take mitigation measures, such as relocating or re-orienting the equipment.

Use of accessories and cables other than those recommended by Fresenius Kabi, could result in increased emissions and / or decreased immunity of the Amika+ system.

If the Amika+ is placed near devices such as HF surgical equipment, X-ray equipment, NMR, cell phones, DECT phones or wireless access points, portable RFID reader, large scale RFID reader and RFID Tags, it is essential to observe a minimum distance between the Amika+ and this equipment (see *Recommended separation distances between portable and mobile RF communication equipment and pump* on page 69). If the Amika+ causes harmful interference or if it is itself disrupted, the user is encouraged to try to correct the interference by one of the following actions:

- reorient or relocate the Amika+ or patient or disruptive equipment;

- change the routing of cables;
- connect the Amika+ mains plug on protected / backed-up / filtered supply or directly on UPS circuit (uninterruptible power supply);
- increase the separation between the Amika+ and patient or disruptive equipment;
- connect the Amika+ into an outlet on a different circuit from that to which the patient or disruptive equipment is connected;
- in any case, whatever the context, the user should conduct interoperability testing in a real situation to find the right setup and good location.

11.2 Guidance and manufacturer’s declaration - Electromagnetic immunity

The Amika+ pump is intended to be used in the electromagnetic environment specified in the Technical Manual.

The customer or the user of the Amika+ pump should ensure that it is used in such an environment.

11.3 Recommended separation distances between portable and mobile RF communication equipment and pump

The Amika+ pump is intended to be used in an electromagnetic environment in which radiated RF disturbances are controlled.

Users of the Amika+ may prevent electromagnetic interference by maintaining a minimum distance between portable and mobile RF communications equipment (transmitters) and the Amika+ as recommended below and according to the maximum output power of the communication equipment (transmitters).

WARNING



- At 80 MHz and 800 MHz, the separation distance for the higher frequency range applies.
- These guidelines may not apply in all situations. Electromagnetic propagation is affected by absorption and reflection from structures, objects and people.
- The device should not be used next to other equipment. If adjacent use is necessary, the device should be observed to verify normal operation in the configuration in which it will be used (Amika pump with a power cable, a USB cable and a nurse call cable).

12 Services

12.1 Warranty

12.1.1 General conditions of warranty

Fresenius Kabi guarantees that this product is free from defects in material and workmanship during the period defined by the accepted sales conditions, except for the batteries and the accessories.

12.1.2 Limited warranty

To benefit from the materials and workmanship guarantee from our sales representative or agent authorized by Fresenius Kabi, the following conditions must be respected:

- Fresenius Kabi is not liable for loss or damage to the device during transport.
- the device must have been used according to the instructions described in this user guide and other accompanying documents;
- the device must not have been damaged when in storage, at the time of repair, or show signs of improper handling;
- the device must not have been altered or repaired by non-qualified personnel;
- the internal battery of the device must not have been replaced by a battery other than that specified by the manufacturer;
- the serial number (ID/N°) must not have been altered, changed, or erased.

INFORMATION



- In case of failure to comply with these conditions, Fresenius Kabi will prepare an estimate for repairs covering the parts and labour required.
- When a return and/or a repair of the device are required, please contact your Fresenius Kabi sales representative.

12.1.3 Warranty conditions for battery and accessories

Batteries and accessories may have specific conditions of warranty.

Please contact your Fresenius Kabi sales representative for additional information.

12.2 Quality control

Upon request by the hospital, a **quality control** check can be performed on the Amika+ **every 12 months**.

A regular quality control (not included in the guarantee) consists of various inspection operations listed in the technical manual. Please refer to the technical manual or contact your Fresenius Kabi sales representative.

INFORMATION



- These checks must be performed by trained technical personnel and are not covered by any contract or agreement provided by Fresenius Kabi.

- For more information, please contact our Fresenius Kabi sales representative.

12.3 Maintenance requirements

WARNING



- Perform preventive maintenance at least once every **3 years**. This includes battery and membrane replacement. To avoid pumping performance deterioration, it is important to follow maintenance requirements.
- Preventive maintenance must be performed by qualified and trained technical personnel in compliance with the technical manual and procedures.
- The qualified personnel must be informed if the device is dropped or if any malfunction occurs. In this case, the device must not be used. Please contact your biomedical department or Fresenius Kabi.
- When replacing components, only use Fresenius Kabi spare parts.
- When using the device on a patient, no maintenance action must be performed.

Life cycle of Amika+ pump: 10 years provided that the maintenance is properly performed as described above.

12.4 Service policy and rules

For further information concerning device servicing or use, please contact our sales representative or our Customer service.

If the device must be sent for servicing, contact Fresenius Kabi to have packaging shipped to your facility.

Clean and disinfect the device, because of potential harm or risks to staff health. Then pack it in the provided packaging and ship to Fresenius Kabi.



INFORMATION

Fresenius Kabi is not liable for loss or damage to the device during transport.

13 Ordering information

Amika+ pump is available in several countries, contact your Fresenius Kabi sales representative for orders.

13.1 Instructions for use

Several 'Instructions for use' documents translated into local languages are available. Please contact your Fresenius Kabi sales representative for orders.

13.2 Giving sets

Do not use Amika giving sets to deliver liquids using gravity method, except the Amika set Varioline Comfort that can be used either for feeding by pump or by gravity.

Giving sets are single use. Whatever the giving set, the performance of the pump is maintained.

	ENFit Transition Sets	ENFit Sets	ENFit Sets with cover
Amika EasyBag	7751907	7751900	7751917
Amika EasyBag Two Line	7751910	7751903	7751994
Amika EasyBag mobile	7751999	7751905	7751916
Amika Varioline	7751909	7751902	7751919
Amika Varioline Comfort	7751998	-	7751904
Amika Bag	7751908	7751956	7751914
Amika Bag mobile	7751913	7751906	7751915
Amika Easy Bag without Medication port	-	-	7751918

13.3 Accessories

Do not use the device with damaged accessories.



WARNING

Use ONLY recommended accessories described below or delivered with the device. Patient must not be connected to the set when installing the pump with accessories. Please refer to its specific instructions for use.

Accessories	Reference
Amika Backpack Large	7752323
Amika Backpack Small	7752343
Amika Universal Table Top Stand	7751082

Accessories	Reference
Smart Holder Power EU Accessory	CS1000428
Smart Holder COM EU Accessory	CS1000429

Please contact your Fresenius Kabi sales representative for orders.

14 Glossary of terms

Term	Description
°C	Celsius Degree
A	Amper
AC	Alternating Current
Ah	Ampere hours
Amika+	Enteral feeding and hydration pump manufactured by Fresenius Kabi
CE mark	European Conformity Mark
CISPR	Special International Committee on Radio Interference
cm	Centimeters
dB	Decibel
DECT	Digital Enhanced Cordless Telecommunications
ECG	Electrocardiogram
EEG	Electroencephalogram
EMC	Electromagnetic compatibility
EXX	Error message
g	Gram
h	Hours
H x W x D	Height / Width / Depth
HF	High Frequency
hPa	Hecto Pascal
Hz	Hertz
ID/N°	Serial number
IEC	International Electrotechnical Commission
IFU	Instructions for Use
IV	Intravenous
LED	Light Emitting Diode
m	Meters
MHz	MegaHertz
min	Minutes

Term	Description
mL	Milliliter
mL/h	Milliliter per hour
mm	Millimeters
MRI	Magnetic Resonance Imaging
NiMH	Nickel-Metal Hydride
NMR	Nuclear Magnetic Resonance
RF	Radio Frequency
RFID	Radio Frequency Identification
sec	Seconds
UPS	Uninterruptable Power Supply
V	Volt
Vac	Volt Alternating Current
Vdc	Volt Direct Current
W	Watt

Release notes

Date	Software version	Description
May 2018	1.0	Creation

This document may contain inaccuracies or typographical errors. Modifications may thus be made, and included in later editions. Due to the evolution of standards, and of legal texts and materials, the characteristics indicated in the text and images of this document are applicable only to the device with which it is included.

This document may not be reproduced in whole or in part without the written consent of Fresenius Kabi. Amika® is a registered trademark in the name of Fresenius Kabi in selected countries.

Made in France

Revision date: March 2020

Reference: 13887-1_ifu_Amikaplus_eng

<http://www.fresenius-kabi.com>



First CE Mark: 2018

Local contacts for servicing

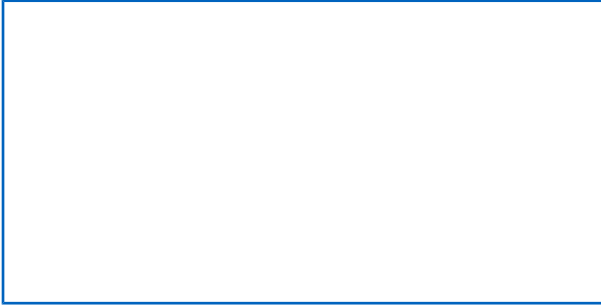

13887-1_ifu_Amikaplus_eng



**FRESENIUS
KABI**

caring for life



Fresenius Kabi AG
61346 Bad Homburg
Germany



Fresenius Vial S.A.S
Le Grand Chemin
38590 Brézins - France