

Transfusion Technology Product Catalogue



**FRESENIUS
KABI**
caring for life

**Advancing
Transfusion
Technology.
*Together.***

Dear Health Care Professional,

This catalogue is designed to support you in your daily work in blood collection and processing. It is a helpful aid in learning about our complete portfolio, ranging from disposable articles to data management systems for manufacturing blood components to microprocessor-controlled cell separators to obtain stem cell products.

We are one of the leading international companies supplying transfusion technology to blood services and hospitals. Our key strength is offering a full range of products, services and methods to achieve the best possible level in blood processing.

Even though we operate worldwide, we provide a strong local base, devoted to providing high value service, innovation, expertise and safety in transfusion technology. In bringing products to markets, our customer representatives have one of the best reputations for support and service and will continue to assist your requests and ideas you may have.

We welcome and appreciate your thoughts and ideas on how we may serve you better. Whether it be new devices or technologies or through service and support, we value your input to our ongoing relationship.



about us

Fresenius Kabi is a leading international health care company focusing on products for the therapy and care of critically and chronically ill patients inside and outside the hospital. We develop, produce and market pharmaceuticals and medical devices. With our corporate philosophy of “caring for life”, we are committed to supporting medical professionals in the best therapy of patients.

In the area of transfusion and blood processing it is our mission to advance Transfusion Technology, together with you. Based on our long expertise, combined with the commitment and dedication of our employees, we are striving to keep the leading position in transfusion technology.

We continuously work to improve our complete portfolio to collect and process blood. Our developments in blood transfusion equipment, disposables, apheresis, autotransfusion and data management are achieved in consultation with international experts in transfusion medicine. The focus is to provide reliable, safe and user-friendly solutions.

Expertise and innovation to meet your needs



With more than 60 years of experience in transfusion devices, we are the worldwide experts in

safe, efficient and convenient blood processing. Our development engineers work continually on new methods to shorten separation cycles and increase the quality of the blood products obtained.

Our excellent reputation has made us a market leader on the transfusion technology market. Innovation, however, is an ongoing process: Fresenius Kabi is driven by the continuous search for new procedures to improve blood processing. In this context it is essential to increase safety, comfort, efficiency and the quality of blood transfusion.

High quality standards for higher treatment safety



Fresenius Kabi is consistently recognized for excellent product quality, resulting from stringent production standards. Our processes are developed internally and subject to continuous quality controls.

Fresenius Kabi's production facilities for transfusion technology products are certified according to international ISO standards and meet the requirements of the relevant medical directives. The results are products and solutions for our customers that meet strict international regulations on quality management in GMP terms. Environmental aspects are strictly followed.

Operating worldwide with strong local presence



Our international presence and infrastructure are our key strengths. We research and develop, manufacture,

sell and distribute all around the world, close to where our customers need us. Our decentralized organisation allows us to best meet the requests and demands of our customers and patients. To achieve this target, we place a special emphasis on highly motivated and well-trained staff.

Everything available from one source



In the area of transfusion technology, we offer a comprehensive range of blood processing equipment,

customized blood bags and filter systems for transfusion centers and hospitals. The ability to provide a complete process solution is unique:

- CompoFlex®/CompoSelect®, blood bag and in-line systems
- CompoMat® G5, blood component processing system
- AMICUS, multi-procedural apheresis platform
- Aurora, plasmapheresis device
- ALYX mobile, automated red blood cell collection
- C.A.T.S.^{®plus}, Continuous AutoTransfusion System

We continue to look forward to fulfilling your blood transfusion needs in the future.

The signs/names marked with "®" are registered trademarks of the Fresenius Group in selected countries.

table of contents



1. SEPARATION

AMICUS Separator
Aurora
ALYX
LOVO
COM.TEC®
DXT

2. DONATION

CompoLab TS
CompoLab TM
CompoGuard®
CompoCool®
CompoSeal Mobilea II
CompoSeal Universal
HemoSeal
CompoCouch
Dacor Donor Chair
Tube Stripper
Hand Sealer for metal clips

3. PREPARATION

CompoSelect®
CompoFlex®
CompoFlow® Flexible and CompoFlow® Select
BioR
BioP
CompoStop flex
InterSol
CompoSol®
CompoMat® G5
CompoDock®
Helmer Platelet Incubators and Agitators
Helmer Plasma Thawers
Helmer Refrigerators and Freezers
Hematype®
CompoVision
RFID Technology
Manual Plasma Extractor

4. SPECIALIZATION

CompoFlex® Transfer Bags
CB COLLECT
Stemcare® Set
Bone Marrow Collection Kit
HemoFreeze

1. SEPARATION

AMICUS Separator

The AMICUS Separator device provides superior cell separation to optimize component collection, depletion and exchange from a single donor or patient



Versatile, high-performance collections of multiple components; including platelets, plasma, red cells and mononuclear cells

Capable of performing efficient therapeutic plasma exchange (TPE) procedures

DXT (data management features) are available to help improve operational efficiencies and reduce paper-based documentation requirements



Major benefits of the AMICUS Separator – Platelets

- High collection efficiency yields multiple products per donor for the lowest-cost platelet production
- Automated integration of PAS (platelet additive solution) to the final platelet product
- Automatic calculation of product options with flexibility for operator adjustment
- Choice of double or single needle procedure
- Intuitive touch-screen
- Integrated tray for simple kit installation
- Kits sterilized using irradiation to avoid risk of exposure to residual ethylene oxide

Major benefits of the AMICUS Separator – Therapeutics (MNC/TPE)

AMICUS allows operators to select the start and end points of “harvest”, providing ultimate flexibility of cell product volumes and can limit cell collections to only targeted cells.

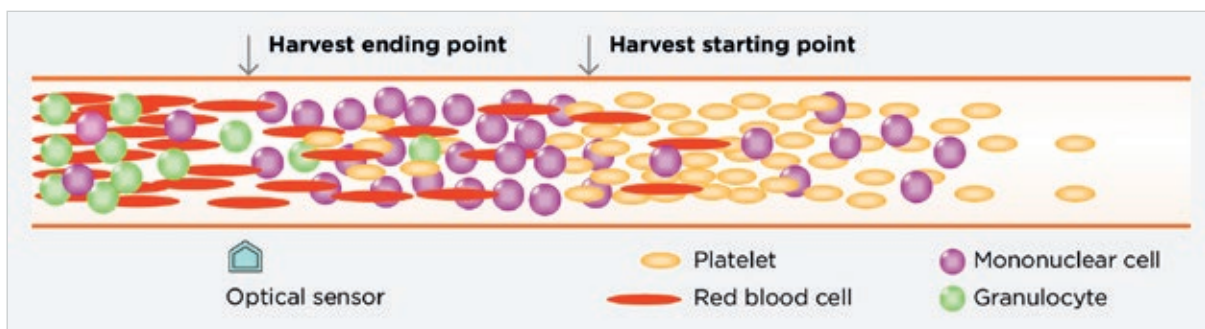

Additional key features include:

- Consistent conservation (sparing) of patient platelets
- Low extracorporeal volume - MNC (163 ml) and TPE (160 ml)
- Operator-selected maximum citrate return rate to patient
- Automated blood warmer tubing prime
- Kits sterilized using irradiation to avoid risk of patient exposure to residual ethylene oxide
- Automatic replacement fluid container switching
- “Prime and Go” feature
- Screen displays real-time fluid balance
- Summary screen gives detailed procedure overview, reducing calculations
- High MNC collection yields and plasma removal efficiency

Technical data

Dimensions (L × W × H)	81 cm × 52 cm × 97 cm	
Weight	139 kg	
Power supply	North & South America	Europe
	105 to 125 V	180 to 264 V
Max. Power Consumption	1200 VA	

Ordering information: Instrument

4R4580	AMICUS Separator
4R4580R	AMICUS Separator (refurbished)

Ordering information: Plateletpheresis leukocytes reduced

AMICUS Platelet Kits	No solutions attached (functionally-closed kits)	PAS-Ready for US InterSol (4B7850)	Single needle	n.a.
			Double needle	n.a.
		PAS-Ready for EU InterSol (CDB8110)	Single needle	R4R2337, D4R2307 (France), F4R2337 (UK)
			Double needle	R4R2340
		NOT PAS-Ready	Single needle	R4R2316 (China)
			Double needle	R4R2314 (China)
	Solutions attached (closed kits)	PAS-Ready for US InterSol (4B7850)	Single needle	4R2337 (US), U4R2337 (LA region)
			Double needle	4R2340 (US)
		PAS-Ready for EU InterSol (CDB8110)	Single needle	n.a.
			Double needle	n.a.
		NOT PAS-Ready	Single needle	4R2357 (US), 4R2312, 04R2312 (India)
			Double needle	4R2355 (US)

Ordering information: Red cell collection ancillary kits

TGR 7225B (w/SAGM)	Ex-US	AMICUS red blood cell set with SEPACELL R-3000 red blood cell leukocyte reduction filter
--------------------	-------	--

R4R2337	AMICUS kit for platelets
---------	--------------------------

Ordering information: MNC collection

4B7891X	Anticoagulant citrate dextrose solution - 1000 ml, formula A
4B7898Q	Anticoagulant citrate dextrose solution - 500 ml, formula A
4B7899Q	Anticoagulant citrate dextrose solution - 500 ml, formula B
R4R2326	AMICUS apheresis kit - Mononuclear cell kit

Ordering information: TPE procedure

R4R2339	AMICUS exchange kit
R4C2170	Blood component filter
Call for information	AMICUS solution pole

Ordering information: Specialty kit items

4R2335H	Product sample pack
4R2350	PL2410 plastic storage, 1000 ml - with tubing leads

Ordering information: AMICUS accessories

112680994	AMICUS Separator's operator's manual -CD
112681016	AMICUS Separator's operator's manual -paper
4994000256	Lint free lens cleaning cloth
4994000278	12' coiled tubing with connectors to AMICUS Separator for use with regular adult cuff and large adult cuff
6001268042	Regular adult cuff with tubing for AMICUS Separator
6001268047	Large adult cuff for AMICUS Separator (requires part 4994000278)
0112681131	Cassette gaskets kit for AMICUS Separator
072730801	White thermoformed cassette protective cover for AMICUS Separator
A10399001	Prompt grip for AMICUS Separator
A10410001	Retaining ring (Gimbal) - AMICUS Separator
A30423002	Foam filter for use with AMICUS Separator
B70000089	Power cord for AMICUS Separator

Certifications

- FDA cleared
- CE marked Class III, 60601-1 3rd Edition Compliant

Manufacturer: Fenwal Inc., Three Corporate Drive, Lake Zurich, IL 60047, USA
 EC Rep.: Fenwal Europe sprl, Rue Edouard Belin 2-4, 1435 Mont-Saint-Guibert, Belgium

Other products related to AMICUS Separator that may be of interest to you

	
<p>Bone Marrow Collection Kit</p>	<p>LOVO Cell Washing Instrument</p>

For more information on this product, please contact your local sales representative.

Aurora

Aurora is an automated system that streamlines plasma collection, producing virtually cell-free plasma



Power and
productivity
with touch
screen
simplicity



Major benefits of the Aurora Plasmapheresis System

- Interactive touch screen facilitates troubleshooting and improves procedure data access
- 2-way data communication with DXT Relay improves center's data management capabilities
- Enhanced vein control is designed to more consistently maximize flow rates
- Modern donor's display with more useful information improves donor's satisfaction
- Low extracorporeal volume (200 ml) minimizes the risk of adverse reaction
- Kits sterilized using irradiation to avoid risk of exposure to residual ethylene oxide
- Smart-Connect kits decrease the risk of mis-spiking solutions
- Virtual cell-free plasma

Technical data

Dimensions	68.6 cm base width × 55.9 cm base depth × 189.2 cm height
Weight	42.6 kg
Power supply	120 - 240 V

Ordering information: Aurora plasmapheresis system

6R4601	Aurora plasmapheresis system
S4R2251C	Smart connect Plasmacell-C disposable set with attached 1,000 ml PlasmaLink transfer pack container
S4R2252C	Smart connect Plasmacell-C disposable set
S4R2280	Smart connect Plasmacell-C disposable set with attached 1,000 ml transferpack container and needle

Ordering information: Aurora accessories

R4R2247	Plasma transferpack 1,000 ml
R4R2069	PlasmaLink bottle 1,000 ml
P94016MGE	MEDISYSTEM apheresis fistula needles 16GA
P94017MGE	MEDISYSTEM apheresis fistula needles 17GA
S8221616	SYSLOC apheresis needles 16GA
BDB8654	4% Sodium Citrate anticoagulant solution 250 ml (Western European languages)
KDB8654	4% Sodium Citrate anticoagulant solution 250 ml (Western European languages)
AZDB8654	4% Sodium Citrate anticoagulant solution 250 ml (Eastern European languages)

Certifications

- FDA cleared
- CE marked Class IIb, 60601-1 3rd Edition Compliant

Manufacturer: Fenwal Inc., Three Corporate Drive, Lake Zurich, IL 60047, USA
 EC Rep.: Fenwal Europe sprl, Rue Edouard Belin 2-4, 1435 Mont-Saint-Guibert, Belgium

ALYX

The ALYX Component Collection
System brings exceptional
mobility and ease-of-use to
apheresis RBC collection

DXT
DATA
MANAGEMENT
POWERED



ALYX
expands the
possibilities
for blood
center
efficiency



Major benefits of the ALYX Component Collection System

- Improves blood drive efficiency by
 - Collecting 2 units of RBCs from a single donor
 - Recovering a single unit if necessary
 - Managing donors to collect the most needed RBC blood types
- Easy to take on mobile blood drives - compact design and optional robust cart with stair climbing wheels
- Fits busy schedules with short procedure times - average less than 30 minutes
- ALYX expands the possibilities for blood center efficiency
- Provides greater donor comfort by giving saline to the donor
- Ability to download collection (or procedure) data to a data management system via a Wi-Fi or wired connection
- Easy to learn and use, with icon-based touch screens
- Attached solutions for greater convenience and safety



Instrument technical data

Dimensions (L × W × H)	53 cm × 46 cm × 66 cm (open position)	
Weight	24 kg	
Power supply (90 - 264 V AC)	N. America 120 V	Europe 250 V

Ordering information

4R5725	ALYX Component Collection System instrument
4R5726	ALYX Ancillary
4R5700	RBC/Plasma kit Collection of 1 unit RBCs, 2 units plasma Closed system with leukoreduction filter English language only (not CE marked)
U4R5701	2RBC-LR kit Collection of 2 units RBCs Closed system with leukoreduction filter English and Spanish languages
R4R5705P	EU red cell kit Collection of 2 units RBCs Closed system with leukoreduction filter English and European languages
4R5720	2RBC-LR kit Collection of 2 units RBCs Closed system with leukoreduction filter English language only

Accessories ordering information

4R5710	ALYX fixed work station
R4R5728	ALYX cart
1571270382	Dual leukofilter fixture assembly
4078502050	ALYX fan filter 0.3 mm thickness
4994000278	12' coiled tubing with connectors for use with regular adult cuff and large adult cuff
5930007171	20' power cord
6001268041	Large adult cuff (requires part 4994000278)
556524003T	ALYX blood pressure cuff assembly

Certifications

- FDA cleared
- CE marked Class IIb

Manufacturer: Fenwal Inc., Three Corporate Drive, Lake Zurich, IL 60047, USA
 EC Rep.: Fenwal Europe sprl, Rue Edouard Belin 2-4, 1435 Mont-Saint-Guibert, Belgium

Other products related to ALYX that may be of interest to you

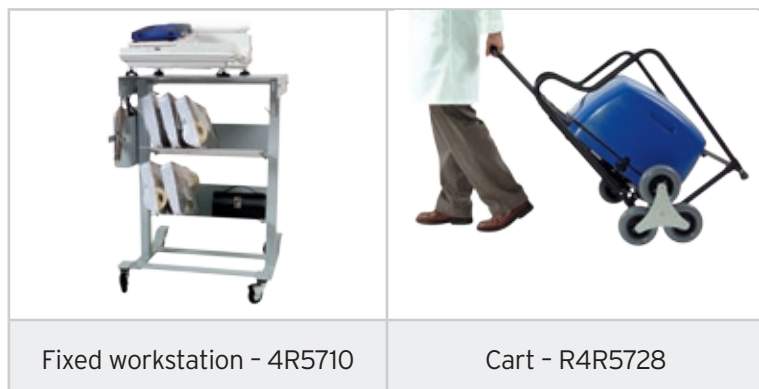

For more information on this products, please contact your local sales representative.

LOVO

Automated
laboratory
cell processing
system





The smartest
way to wash
white blood
cells



Major benefits of the LOVO laboratory cell processing system are:

- Standardization of cell washing in a one-step process
- Automated system
- Time savings compared to centrifugation
- Maintenance of cell viability through non-pelletizing process
- High cell yield
- Flexible volume range for source and end product
- Data transfer via USB stick



Technical data

Dimensions (L × W × H)	50.5 cm × 45.7 cm × 67.3 cm
Weight	34 kg
Power supply	120 - 240 V, 2 A, 50 - 60 Hz, 480 W

Ordering information

6R4900	LOVO laboratory instrument
X6R4901	LOVO cell washing disposable kit, 20/case, shelf life: 24 months
X6R4902	LOVO ancillary bag kit, 20/case, shelf life: 24 months

Sterile disposables are for research purpose

Certifications

LOVO is a CE marked laboratory instrument under

- Low Voltage Directive (2006/95/EC)
- EMC Directive (2004/108/EC)
- RTTE Directive (1995/5/EC)

and is in compliance with IEC 61010 2nd ed., IEC 61326 2nd ed.

COM.TEC®

Therapeutic apheresis
flexibility and versatility
for therapeutic
procedures



The ultimate
device for
therapeutic
procedure
versatility



Major benefits of COM.TEC® are:

- Broad range of therapeutic apheresis:
 - Lymphocyte collection
 - Red cell depletion and exchange
 - White cell and platelet depletion
 - Granulocyte collection
 - Fully automated stem cell collection
 - Plasma treatment with external devices; including absorber columns
- Confidence in quality and performance
- Excellent donor safety
- Dual and single needle options for leukocyte-reduced platelet concentrates
- Color displays



Technical data

Dimensions (L × W × H)	60 cm × 66 cm × 140 - 180 cm
Weight	130 kg
Power supply	100 V -240 V
Power back-up	24 V (2 × 12 V), 3 Ah
Article code	9008021 (CE and RoW version) 9008021C (IT specific version with CE) 9008031 (US specific version)

Ordering information part 1

Article code	Set	DN/SN	Product bags for PLT and stem cells (ml)	Product sample bag	Plasma bag (ml)	SN bag (ml)
9400401	PL1	DN				
9400411	P1R	DN				
9400421	P1Y	DN	2 × 500	✓	500	
9400301	C4Y	DN	500	✓	500	
9400361	RVY	DN	500	✓	500	
9400211	S5L	SN	2 × 1,300	✓	500	500
9400201	C5L	DN	2 × 1,300	✓	500	
9400371	C4L	DN	2 × 1,300	✓	500	
9400221	C5LT	DN	3 × 1,300	✓	500	
9400431	P1YA	DN	3 × 1,300	✓	500	

Disposable for Japan and USA on request

Ordering information part 2

Article code	Waste priming bag (ml)	Spike	Luer-Lock	Chamber	Preconnected inlet needle
9400401	500/5,000	✓		PL1	
9400411	500	✓		PL1	
9400421	500	✓	✓	PL1	✓
9400301	500	✓	✓	C4	✓
9400361	500	✓	✓	C4	✓
9400211	500	✓	✓	C5	✓
9400201	500	✓	✓	C5	✓
9400371	500	✓	✓	C4	✓
9400221	500	✓	✓	C5	✓
9400431	500	✓	✓	PL1	✓
Disposable for Japan and USA on request					

Add-on disposables

5028011	V651 apheresis cannula for venous puncture, 16 g, 1.6 mm × 25 mm
9007321	Spike with Luer-Lock, female
9007301	Blood component collection bag, with Luer-Lock, 500 ml
9007451	500 ml transfer bag for simultaneous plasma collection
5027851	SN adaptor, Luer-Lock
6414691	Printer paper, type 4401
9007341	Bone Marrow (BMSC) bag set (2 × 2500 ml)

Ordering information accessories

6610521	Chamber holder for chamber C4 (dual stage chamber)
6610381	Chamber holder for chamber PL1 (single stage chamber)
6611141	Chamber holder for chamber C5 (single stage chamber)
6791821	Printer
6791811	Printer cable
6792011	Printer holder
9009301	SN bag press (only necessary for emergency single needle)
6747011	Donor display
6711401	Pressure cuff (necessary for single needle)
6797441	Table
6797501	Rubber pad (table)
6730741	Rubber pad (device)
6797571	Storage bar for chamber holder

Certifications

- Class IIb accord. EC-Directive 93/42/EEC
- CE marked, IEC 60601-1 3rd Edition Compliant
- Cleared for sales in the US (article code 9008031)

Other products related to COM.TEC® that may be of interest to you



DXT

Supporting software for AMICUS
Separator, Aurora and ALYX: electronic
records and data communication for
efficient center management

The Power of Information



Supporting software
for AMICUS
Separator, Aurora
and ALYX: electronic
records and data
communication
for efficient center
management

Major benefits of DXT are:

- Two way communications with Donor Management Systems
- Anytime, anywhere access to data
- Electronic records to minimize errors
- Procedure reports to improve blood center operations
- Also available for therapeutic applications

DXT Relay - AMICUS Separator report sample listing

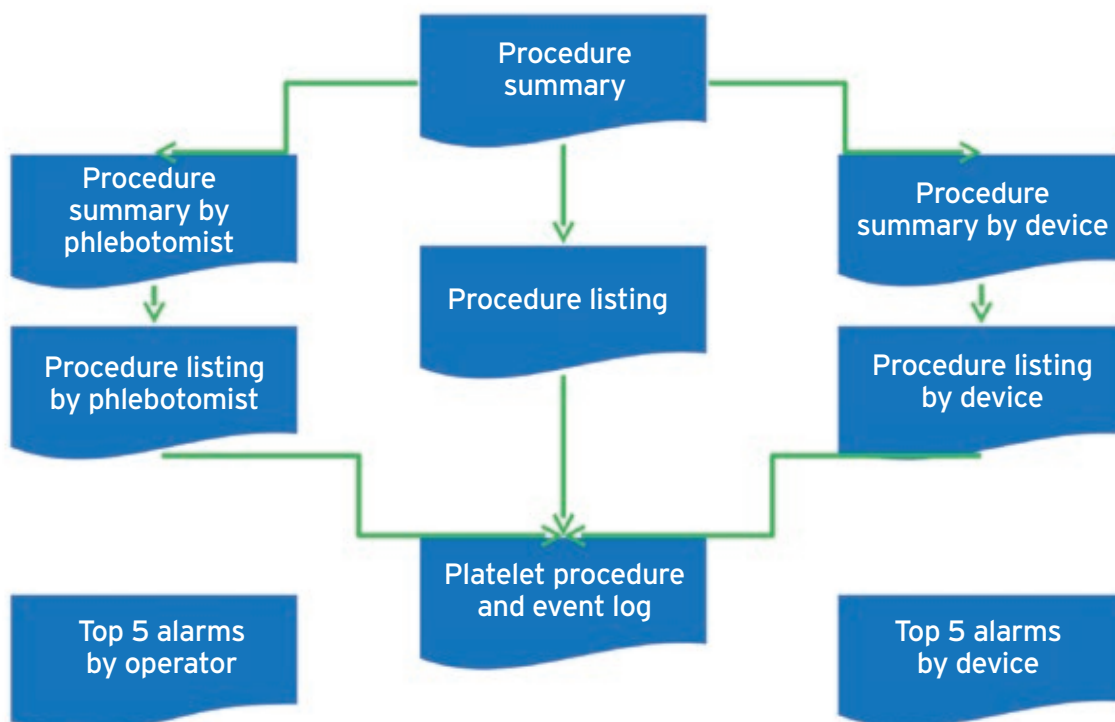

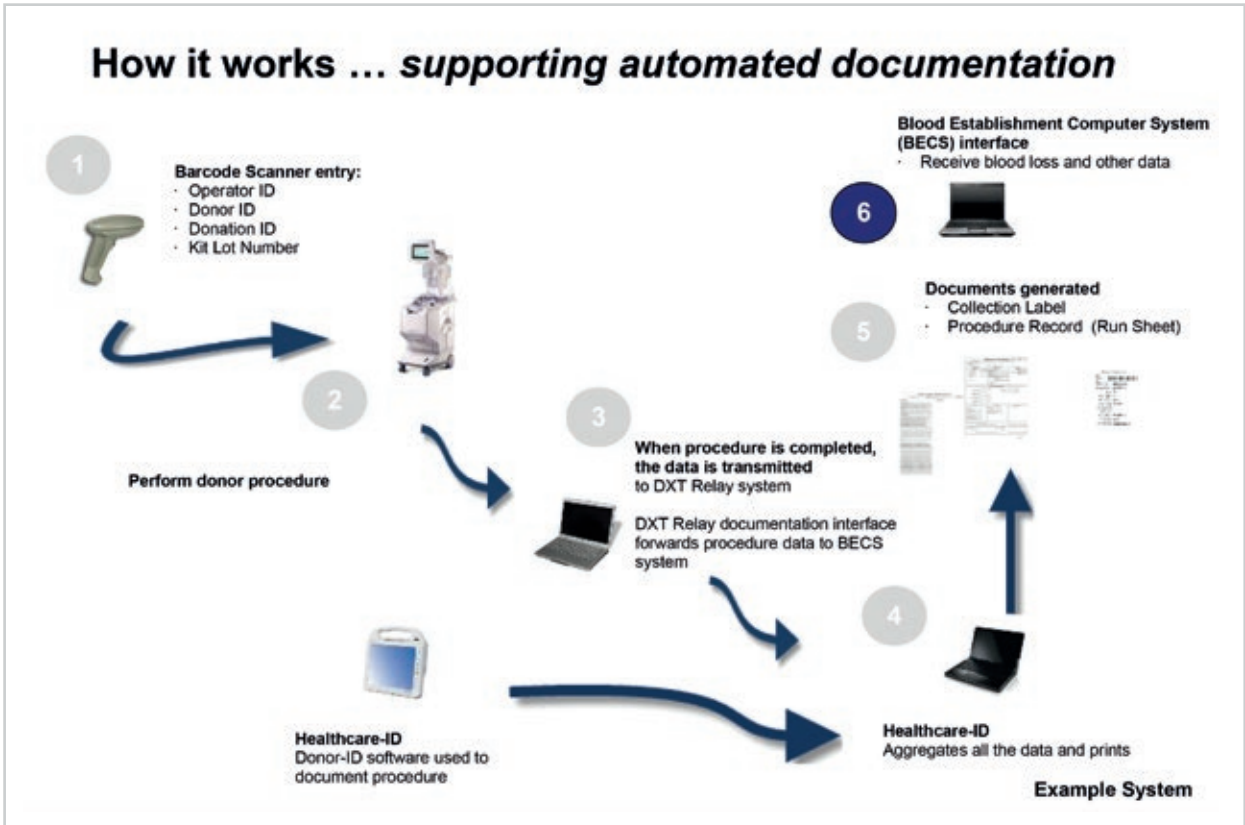

Ordering information

5S9802	DXT Relay v. 2.2 DVD
6113983433	DXT Relay v. 2.2 operator's manual
6113983434	DXT Relay v. 2.2 administrator's guide

Other products related to DXT that may be of interest to you

		
AMICUS Separator	Aurora	ALYX

2. DONATION

CompoLab TS

Innovative
hemoglobin
screening
technology





12.6 g/dl

126%

hct~37%



CompoLab TS

FRESENIUS
KABI

Innovative hemoglobin screening technology



CompoLab TS is one of the fastest devices for measuring hemoglobin from human whole blood. Using a motor driven cuvette holder, operation has become very easy while ensuring excellent measuring accuracy at the same time.

Major benefits of CompoLab TS are:

- Measures hemoglobin within 2 seconds
- Reagent free disposable not influenced by temperature and/or moisture
- Accurate measurement using broad spectrum photometer



Technical data

Dimensions (L × W × H)	140 mm × 215 mm × 70 mm
Weight	500 g
Power supply	100 - 240 V AC, 50 - 60 Hz
Battery	<ul style="list-style-type: none"> - 3.6 V integrated Li-Ion batteries - Approx. 40 h continuous, with a fully charged battery - A completely drained battery requires about five hours to fully charge
Measuring range	0 - 255 g/L (0 - 25.5 g/dL, 0 - 15.9 mmol/L)
Measurement accuracy	+/-0.3 g/dL for 0 - 20 g/dL +/-0.7 g/dL for > 20 g/dL, compared to HiCN, ICSH
Storage cuvettes	Cuvettes can be stored at 0°C to +50°C and temperatures of -30°C to +70°C during transport are permitted within 24 hrs max.
Storage device	0°C to 50°C (-30°C to +70°C during transport, 24 h max.)

Ordering information

9033300	CompoLab TS, in transport case, including power adapter and manual
9033310	CompoLab TS cuvette, 100 cuvettes in foil bag (5 bags per case)

Certifications

- IVD-Device accord. EC-Directive
- CE marked, IEC 61010 2nd and 3rd Edition Compliant
- Cleared for sales in the US

Manufacturer: DiaSpect Medical GmbH, Von-Cancrin-Straße 1, 63877 Sailauf, Germany

CompoLab™

Fast
handheld
hemoglobin
analyzer





**FRESENIUS
KABI**

CompoLab TM

Fast
handheld
hemoglobin
analyzer



Major benefits of CompoLab TM are:

- HB measurement result **within 2 seconds**
- Long-lasting battery capacity
- Optional data transfer via USB cable (optional Bluetooth, special software needed)
- Small size - Large display
- No moving parts
- Reagent-free cuvettes with long expiration dating



Technical data

Dimensions (L × W × H)	150 mm × 90 mm × 40 mm
Weight	Approx. 180 g
Power supply	100 - 240 V AC, 50 - 60 Hz
Battery	3.6 V integrated Li-Ion batteries
Duration of use	Several weeks with a fully charged battery and continuous use
Measuring range	0 to 25.5 g/dl (0 to 255 g/L; 0 to 15.9 mmol/L)
Measurement accuracy	1.8 - 25.4 g/dl within +/- 1.3% to ICSH
Sample volume	< 10 µl
Operating temperature	+10 °C to +35 °C
Storage device and cuvettes	0 °C to +50 °C (-30 °C to +70 °C during transport, max. 24 h)

Ordering information

9034000	CompoLab TM including power adaptor and manual
9033310	CompoLab TM/TS cuvettes, 100 cuvettes in foil bag (5 bags per case)
9034010	CompoLab TM transport case
9034030	CompoLab TM Scanner
9034040	USB 2.0 - HUB 7-Fold
9034020	CompoLab TM Hb-Master
9033070	CompoLab Control HBT: 3 × HBT-Low
9033080	CompoLab Control HBT: 3 × HBT-Medium
9033090	CompoLab Control HBT: 3 × HBT-High
9033100	CompoLab Control HBT: 1 × HBT-Low, 1 × HBT-Medium, 1 × HBT-High

Certifications

- EC-Directive 98/79/EC
- CE marked, IEC 61010 compliant

CompoGuard®

Innovative
mixer
technology





Combining
safety with
efficiency in whole
blood
donation



Major benefits of CompoGuard® are:

- Increased number of donations per fully charged battery
- Increased data management flexibility
- One further step towards paperless donation
- Comfortable working station
- Donors can directly monitor their donation progress
- Documentation of barcodes and sealings
- Robust transport case with charging option suitable for mobile donation



Three different models:



CompoGuard® Basic



CompoGuard® Data
Basic model
+ DECT option
+ Gooseneck
+ USB port



CompoGuard® Complete
Basic model
+ DECT option
+ Gooseneck
+ USB port
+ sealing option
+ rechargeable battery

Technical data

Device (L × W × H)	445 mm × 225 mm × 165 mm
Gooseneck panel (L)	460 mm
Transport case (L × W × H)	530 mm × 250 mm × 280 mm
Optenna (max. pulled out length)	440 mm
Weight CompoGuard® (without battery)	3.4 kg
Weight Transport case	2.8 kg
Power supply	100 - 240 V, 50 - 60 Hz

Ordering information

9029601	CompoGuard® Basic Basic model (excl. battery)
9029611	CompoGuard® Data Basic model + DECT option + Gooseneck (excl. battery and bar code reader)
9029621	CompoGuard® Complete Basic model + DECT option + sealing option + rechargeable battery + Gooseneck (excl. bar code reader)

Ordering information data management accessories

M638421	Upgrade Option DECT for model "Basic"
M690041	Upgrade Option DECT for model "Basic" (USA/Canada)
9028891	Barcode scanner with integrated auto-sense function
9028341	DECT Fixedpart for radio transmission network, EU* One per PC/network; includes power supply and cable
9029001	DECT Fixedpart clone, EU* Fixed-part clones all have the same DECT-ID number
9029361	DECT Fixedpart for radio transmission network, USA/CDN* One per PC/network; includes power supply and cable
9029461	DECT Fixedpart clone, USA/CDN* Fixed-part clones all have the same DECT-ID number
9028641	DECT Fixedpart for radio transmission network, UK* One per PC/network; includes power supply and cable
9029331	DonationMaster Net 2.5.x.x multilingual CD-ROM and multilingual manual
9029631	Upgrade kit for activating the data management for model "Basic"

* additional country/language versions available upon request

Ordering information data management accessories

9028331	Network converter RS485, EU (necessary for cable network only); includes power supply and cable. One converter per PC/network
9028601	Network converter RS485, USA/CDN (necessary for cable network only); includes power supply and cable. One converter per PC/network
9028611	Network converter RS485, UK (necessary for cable network only); includes power supply and cable. One converter per PC/network
9029281	Network converter RS485, AU/NZ (necessary for cable network only); includes power supply and cable. One converter per PC/network
M636701	Y-piece (necessary for cable network only) Number: one less than number of mixers in a network
M636671	Network cable, 5 m (necessary for cable network only) Number: one less than number of mixers in a network
M686791	USB adapter cable for Fixedpart (USB to RS232) With this adapter cable the Fixedpart can be connected to a PC with USB port
9029541	USB 2.0 Stick for CompoGuard®

Ordering information accessories

9029471	Transport case for CompoGuard® Space for all accessories inside the transport case
9029481	Transport case with charging option External plug for in-case charging of battery
M687051	Rechargeable battery for CompoGuard®, Li-Ion technology
9029491	4-fold charger for CompoGuard®, EU For four Li-Ion batteries, 230 V
M684251	Power adapter with charging indication lamp 100 - 240 V, 50 - 60 Hz country specific plug adapters are separately available
9029531	Gooseneck - Includes holder for scanner and hand sealer; included in models "Data" and "Complete"
M657981	Disinfectable filter holder 1 pc

Certifications

- Class IIa accord. EC-Directive 93/42/EEC
- CE marked, IEC 60601-1 3rd Edition Compliant

Other products related to CompoGuard® that may be of interest to you



CompoCool®

A unique whole blood
cooling, transport
and storage system

CompoCool®

CompoCool® WB

The cooling system
for protected whole blood
during transport and storing

Blood
cooling
during
transport
and
storage



Major benefits of CompoCool® are:

CompoCool®

- Safe and standardized cooling of whole blood at 20 - 24°C up to 24 hours
- Contributes to quality and standardization of blood component preparation:
 - increased and more consistent platelet yield
 - stabilizes factor VIII during storage
- Reduces component processing outside normal working hours
- Standardizes the temperature of the individual whole blood units

CompoCool® WB

- Insulated transport box enables cooling at 22°C (\pm 2°C) within 2 hours for up to 24 hours
- Small cooling element with integrated temperature control
- CompoCool® WB box designed for ergonomic transportation
- Easy to clean
- Foldable trolley for a comfortable transport of up to 24 blood units
- Secure blood transport with sealable boxes

Technical data CompoCool®

Models/Accessories	Dimensions (L × W × H)	Weight
CompoCool® cartridge (standard)	460 mm × 335 mm × 25 mm	3 kg
CompoCool® crate for cooling cartridges	600 mm × 400 mm × 120 mm (up to 5 crates stackable)	1 kg
CompoCool® cartridge (small)	Special dimensions: 190 mm × 290 mm × 25 mm	1.2 kg
Transport trolley for 5 crates	620 mm × 420 mm × 150 mm	3.9 kg
Push bar for transport trolley	Position dimensions: 0 mm × 0 mm × 870 mm	4.9 kg

Technical data CompoCool® WB

Models/Accessories	Dimensions (L × W × H)	Weight
CompoCool® WB insulated transport box + cooling element	425 mm × 334 mm × 245 mm	3 kg
CompoCool® WB insulated transport box	425 mm × 334 mm × 245 mm	1 kg
CompoCool® WB cooling element	306 mm × 45 mm × 165 mm	1.2 kg
CompoCool® WB trolley transport position extended position	60 mm × 490 mm × 780 mm 560 mm × 500 mm × 1,090 mm	3.9 kg

Ordering information CompoCool®

9024251	CompoCool® cartridge (standard), 6 - 8 whole blood units fit on one cartridge, minimum order quantity: 4 units
9024261	CompoCool® crate for cooling cartridges
9028161	CompoCool® cartridge (small) minimum order quantity: 4 units
9024271	Transport trolley for 5 crates
9024541	Push bar for transport trolley



Ordering information CompoCool® WB

9028821	CompoCool® WB insulated transport box + cooling element for maximum 6 units
9028841	CompoCool® WB insulated transport box, for maximum 6 units
9028751	CompoCool® WB cooling element
9028831	CompoCool® WB trolley
M658391	CompoCool® WB plugs (seal), color: yellow, packaging size: 1,000 pcs.

Certifications

- CompoCool® WB is CE marked Class IIa accord. EC-Directive 93/42/EEC
- CompoCool® is cleared for sales in the US

Other products related to CompoCool® that may be of interest to you

 A medical setup showing two CompoFlex blood bags connected to a drip chamber and tubing. The bags are clear plastic with labels and are connected via white plastic tubing to a grey drip chamber on the left.
<p>CompoFlex® blood bags</p>
 A medical setup showing four CompoSelect blood bags connected to a drip chamber and tubing. The bags are arranged in a row, connected by white plastic tubing to a grey drip chamber on the left. A small circular component is visible in the tubing above the bags.
<p>CompoSelect®</p>
 A medical setup showing five CompoFlow blood bags connected to a drip chamber and tubing. The bags are arranged in a row, connected by white plastic tubing to a grey drip chamber on the left. A small circular component is visible in the tubing above the bags.
<p>CompoFlow® Flexible and CompoFlow® Select</p>

CompoSeal Mobilea II

Improved
technology for
portable and
safe sealing



New technology
for portable and
safe sealing



Major benefits of CompoSeal Mobilea II are:

- Modern Lithium Polymer battery provides a capacity of up to 1,000 seals per full charge on standard blood bag tubes
- Designed for portable use: Low weight power pack of just 760 g, robust metal housing with rubber pads for shock absorption
- High quality seals independent of the battery capacity
- Automatic adjustment of sealing time depending on tube thickness
- Approved for bedside sealing while donor is connected



Technical data

Description	Dimensions (L × W × H)	Weight
CompoSeal Mobilea II set ¹⁾	395 mm × 106 mm × 295 mm	2,364 g
CompoSeal Mobilea II powerpack	110 mm × 52 mm × 145 mm	760 g
CompoSeal Mobilea II handsealer	215 mm × 65 mm × 30 mm	315 g
CompoSeal Mobilea II power supply unit	65 mm × 75 mm ²⁾ × 130 mm	270 g
CompoSeal Mobilea II handsealer cable	1,470 mm × 5 mm × 5 mm ³⁾	83 g
Transport case for CompoSeal Mobilea II	395 mm × 106 mm × 295 mm	900 g

¹⁾ In transport case, ²⁾ incl. adapter, ³⁾ Length from plug to plug, Ø of the cable itself





Ordering information

9027011	CompoSeal Mobilea II set
9027001	CompoSeal Mobilea II powerpack
9027021	CompoSeal Mobilea II handsealer
9027031	CompoSeal Mobilea II charger
9027041	CompoSeal Mobilea II hand sealer cable
9027051	CompoSeal Mobilea II transport case

Certifications

- Class I accord. EC-Directive 93/42/EEC
- CE marked, IEC 60601-1 3rd Edition Compliant
- Cleared for sales in the US

Other products related to CompoSeal Mobilea II that may be of interest to you

	
CompoFlex® blood bags	CompoSelect®
	
CompoFlow® Flexible and CompoFlow® Select	CompoFlex® Transfer Bags

CompoSeal Universal

Flexible
tube sealing system





Flexible tube sealing system



Major benefits of CompoSeal Universal are:

- Auto-tuning function up to 6 mm medical PVC tube diameter for optimal short sealing time and identical seal thickness¹⁾
- Optional hand sealer for simultaneous operation
- Spark detection and seal time limiter for controlled handling
- Automatic tubing grips to ensure seal quality
- Easy to clean sealing head
- Indication of sealing process

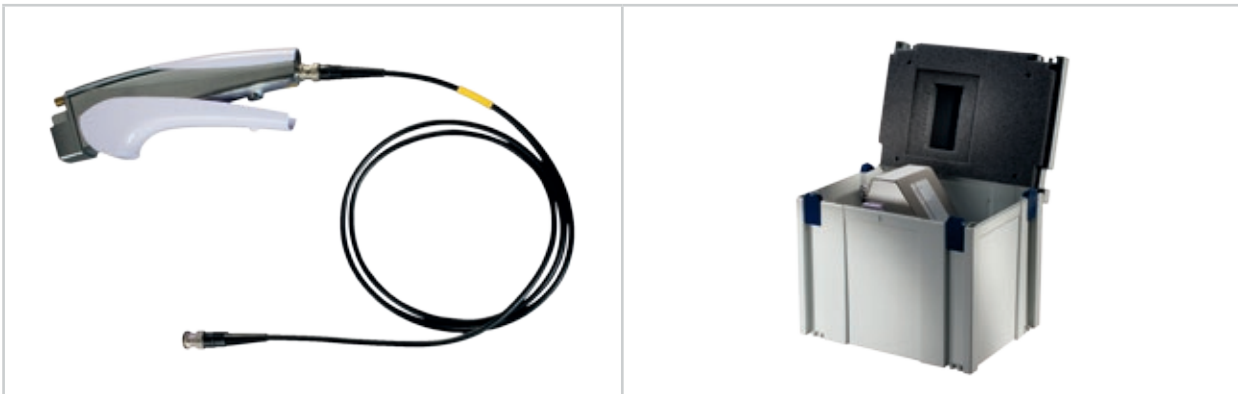

¹⁾ Applies to the front sealing head

Technical data CompoSeal Universal

Dimensions (L × W × H)	280 mm × 150 mm × 260 mm
Weight	7,000 g
Power supply	230 V AC, 50 Hz

Technical data Hand sealer

Dimensions (L × W × H)	215 mm × 65 mm × 30 mm
Weight	315 g

Ordering information





9024061	CompoSeal Universal sealing system 230 V
9025661	CompoSeal Universal sealing system 120 V
9024661	CompoSeal Universal sealing system 120 V (US, CAN)
9026661	CompoSeal Universal sealing system 230 V (China)
9024031	Hand sealer (violet)
9027041	Hand sealer cable
9028811	Transport case

Hand sealer (9024031 and 9027021) fit to CompoGuard® Complete, CompoSeal Mobilea II, CompoSeal Universal

Certifications

- CE marked
- UL approved accord. IEC 61010
- Cleared for sales in the US

Other products related to CompoSeal Universal that may be of interest to you

	
CompoFlex® blood bags	CompoSelect®
	
CompoFlow® Flexible and CompoFlow® Select	CompoFlex® Transfer Bags

HemoSeal

Tube sealing
system for
perfect and
reliable seals





HemoSeal

FRESENIUS
KABI

ON

OK

FAIL

Tube sealing
system for
perfect and
reliable seals



Major benefits of HemoSeal are:

- Controlled and safe tube sealing
- High quality seals
- Reliable operation
- Quick and easy handling



Technical data HemoSeal

Dimensions (L × W × H)	320 mm × 190 mm × 190 mm
Weight	Approx. 8 kg
Power supply	110 V/230 V, 50 - 60 Hz

Technical data Hand sealer

Dimensions (L × W × H)	215 mm × 65 mm × 30 mm
Weight	315 g





Ordering information

81039	HemoSeal International
9027021	Hand sealer
9027041	Hand sealer cable

Certifications

- CE marked
- Cleared for sales in the US

Other products related to HemoSeal that may be of interest to you

	
CompoFlex® blood bags	CompoSelect®
	
CompoFlow® Flexible and CompoFlow® Select	CompoFlex® Transfer Bags

CompoCouch

The comfortable
donation
and apheresis
couches





The
comfortable
donation and
apheresis
couches



Major benefits of the CompoCouch models are:

Evolution A3/A4: The high-end model

The optimal solution for highest quality in transfusion medicine. Evolution A3 allows adjustment of back-, seat- and foot-part. Evolution A4 allows the additional adjustment of the height.

Start A2/A3: The economical model

The Start models have the same construction features as the Evolution models. Through simplified basic chassis and design (seat is fixed), an additional price/benefit relation can be achieved. The Start A3 allows besides back- and foot part adjustment, additionally an adjustment of the height.

CompoChair: The compact model

This model is characterized by being particularly inexpensive. The ideal choice whenever investments have to be made with a reduced budget, but high-quality product features are required.



Technical data

Description	Start A2	Start A3	Evolution A3	Evolution A4	Smart (CompoChair)
Dimensions packaging (L × W × H)	80 cm × 120 cm × 145 cm				60 × 60 × 180 cm
Net weight	87 kg	88 kg	89 kg	90 kg	48 kg
Maximum load	200 kg				150 kg
Width of arm rest	13.5 cm				15 cm
Length of arm rest	60.5 cm				57 cm
Base width	60 cm				54 cm
Base length	219 cm				188 cm
Total overall width	87 cm				81 cm
Distance between arm rests (adjustable)	60 cm				53 cm
Seat/base height	60 cm	56 - 78 cm	60 cm	56 - 78 cm	55.5 cm
Padding and neck support upholstery	skai® (leatherette), flame retardant				
Thickness of padding	8 cm				6 cm
Color frame	Light grey				
Color arm and foot rest	Dark grey				

Technical data

Description	Start A2	Start A3	Evolution A3	Evolution A4	Smart (CompoChair)
4 castors, antistatic	d = 7.5 cm, all lockable		d = 10 cm, all lockable		d = 7.5 cm, all lockable
Electric motor with limit switch	2 × 24 V	3 × 24 V		4 × 24 V	1 × 24 V
Transformer	Protection class II				
Transformer nominal power - Primary - Fuse - Secondary	230 V/50 Hz - 110 V/60 Hz 1 A/T, slow blow 25 V				230 V/50 Hz 1 A/T, slow blow 25 V
Back rest tilt	To 62°		To 72°		To 70°
Seat rest tilt	Fixed 10°		0° to 25°		
Leg rest tilt	12° to -15°		2° to -25°		
Shock positions ¹⁾					
Back rest tilt Leg and seat rest tilt	0° to 14°	0° to 14°	0° to 27°	0° to 27°	
Ambient temperature	3°C - 40°C				
Relative humidity	30% - 75%				

¹⁾ Possible shock positions (not Trendelenburg)



Ordering information

9020521	Start A2 with wedge shaped armrest, light-grey
9020531	Start A2 with wedge shaped armrest, pastel blue
9020561	Start A3 with wedge shaped armrest, light-grey
9020571	Start A3 with wedge shaped armrest, pastel blue
9020601	Evolution A3 with wedge shaped armrest, light-grey
9020611	Evolution A3 with wedge shaped armrest, pastel blue
9020641	Evolution A4 with wedge shaped armrest, light-grey
9020651	Evolution A4 with wedge shaped armrest, pastel blue
9024751	Smart (CompoChair) with wedge shaped arm rest
9024501	Smart (CompoChair) with flat arm rest, grey
9024751	Smart (CompoChair) with wedge shaped arm rest
5067371	Infusion pole
9020701	Infusion pole holder
9020711	Start/Evolution - battery option
9020721	Start/Evolution - LED reading lamp, 24 V
9020731	Start/Evolution push bar, fixed
9020741	Start/Evolution relax pillow, pastel blue
9020751	Start/Evolution relax pillow, light-grey
9028141	Side table ST1 with motionless tray
9028131	Side table DT1 with tray
9020761	Transparent plastic cover for foot part
9020771	Foot rest - automatically adjustable ¹⁾
9020781	Foot rest - mechanically adjustable ²⁾

All couches equipped with paper roll holder/Evolution models with relax pillow

Start models: simplified base construction, armrest without height adjustment and additional neck role

¹⁾ optional for "Evolution" and "Start" not for "Compochair"

²⁾ optional for "Compochair", "Start" and "Evolution"

Certifications

- CE marked Class I accord. EC-Directive 93/42/EEC

Manufacturer: LIKAMED GmbH, Raußmühlstraße 7, 75031 Eppingen, Germany

Dacor Donor Chair

The ultimate
in patient
comfort and
convenience



The ultimate
in patient
comfort and
convenience



Major benefits of Dacor Donor Chair are:

Dacor offers one non-electrical model, the 4R4201.

The 4R4201 features an all-hardwood frame construction and has easily manually adjustable arm rests. A wide selection of vinyl colors is available, all treated to provide protective coating against stains, abrasions and bacterial growth. The shock position can be easily reached by manual lever.

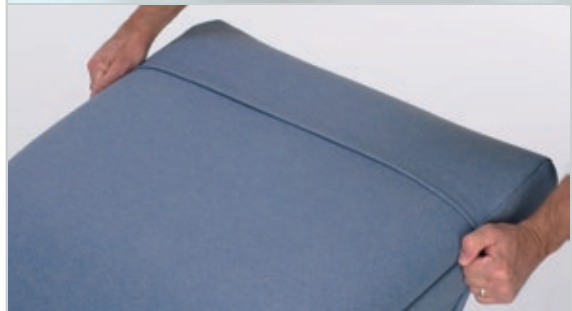

Technical data

Dimensions packaging (L × W × H)	104.14 cm × 78.74 cm × 162.56 cm
Net weight	63.5 kg
Gross weight	79.83 kg
Maximum load	158.75 kg
Length	152.4 cm
Width	83.8 cm
Head height	116.8 cm
Foot height	96.5 cm
Seat height	63.5 cm

Typical dimensions

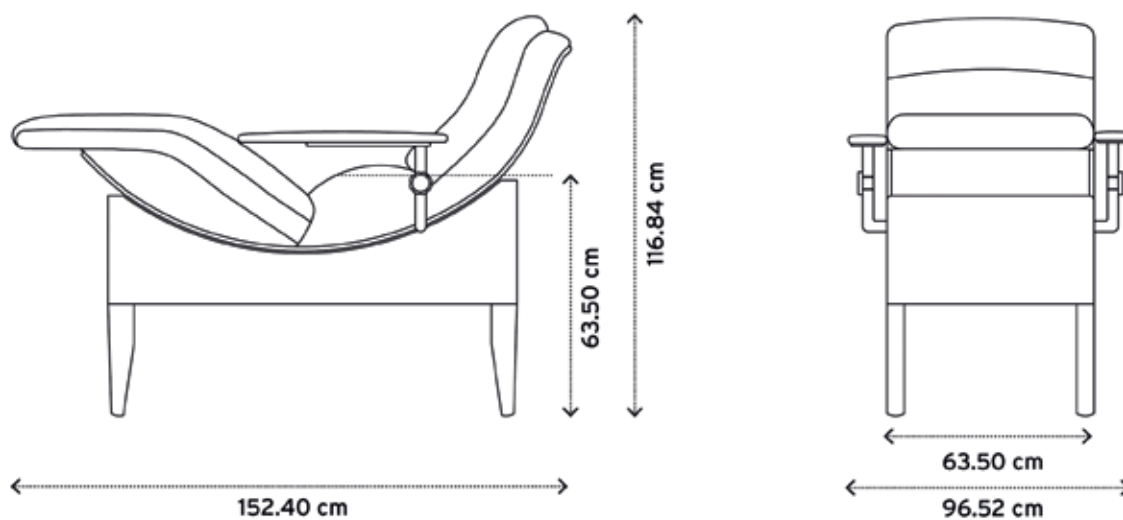

Ordering information: Dacor Donor Chairs

4R4201	Manual Dacor Donor Chair
Please specify the color when you place the order for accessories	

Ordering information: Accessories Dacor Donor Chairs

TRB01	Shock position base
SS4500	Storage shelf for chair
SBS4500	Pull-out step base
CA4	Locking casters for chair
4R49999	Head and foot covers for 4R4201
4R4500	DVD tray attachment
WL4500	Finished maple wood legs

Manufacturer: DACOR Manufacturing.LLC, a company duly incorporated under the laws of the State of Indiana, United States of America, 2061 Hitzert, Fenton, MO 63026 USA

Tube Stripper

Easy to use
Tube Stripper





Easy to
use Tube
Stripper



Intended use of Tube Stripper:

The Tube Stripper is used to strip undiluted blood from donor tubing into blood collection container.

The Tube Stripper works with different types of PVC tubing up to 4.5 mm outer diameter. The roller gap can be easily adjusted with the provided hex key.

Ordering information

6R4452



Tube Stripper with a 2.0 mm hex key and a roller gap gauge

Certifications

- CE marked

Manufacturer: Fenwal Inc., Three Corporate Drive, Lake Zurich, IL 60047, USA
EC Rep.: Fenwal Europe sprl, Rue Edouard Belin 2-4, 1435 Mont-Saint-Guibert, Belgium

Other products related to Tube Stripper that may be of interest to you

 A medical setup showing a tube stripper connected to two CompoFlex blood bags via clear plastic tubing.	 A medical setup showing a tube stripper connected to four CompoSelect blood bags via clear plastic tubing, with a central pump or control unit.
<p>CompoFlex® blood bags</p>	<p>CompoSelect®</p>
 A medical setup showing a tube stripper connected to five CompoFlow blood bags via clear plastic tubing, with a central pump or control unit.	
<p>CompoFlow® Flexible and CompoFlow® Select</p>	

Hand Sealer for metal clips

Convenient
Hand Sealer





Convenient Hand Sealer



Intended Use of Hand Sealer for metal clips:

The Hand Sealer is used to provide a hermetic, cost effective and convenient closure on Blood-Pack Unit tubing.

Hand Sealer clips have been designed to work with the Hand Sealer RAR4417.

Ordering information



RAR4417	Hand Sealer
RDR4418	Hand Sealer clips to be used RAR4417 (1,000 clips)
RDR4418B	Hand Sealer clips to be used RAR4417 (10,000 clips)

Certifications

- CE marked

Manufacturer: Fenwal Inc., Three Corporate Drive, Lake Zurich, IL 60047, USA
EC Rep.: Fenwal Europe sprl, Rue Edouard Belin 2-4, 1435 Mont-Saint-Guibert, Belgium

Other products related to Hand Sealer that may be of interest to you

 A medical setup showing two CompoFlex blood bags connected to a hand sealer. The bags are clear plastic with labels and are connected to a clear plastic tubing system that leads to a hand sealer device.	 A medical setup showing four CompoSelect blood bags connected to a hand sealer. The bags are clear plastic with labels and are connected to a clear plastic tubing system that leads to a hand sealer device.
<p>CompoFlex® blood bags</p>	<p>CompoSelect®</p>
 A medical setup showing five CompoFlow blood bags connected to a hand sealer. The bags are clear plastic with labels and are connected to a clear plastic tubing system that leads to a hand sealer device.	
<p>CompoFlow® Flexible and CompoFlow® Select</p>	

3. PREPARATION

CompoSelect®

Blood component
preparation
with integrated
leukocyte reduction





Blood
component
preparation
with
integrated
leukocyte
reduction



Major benefits of CompoSelect® are:

- Full range of in-line filter systems suitable for different kinds of blood component preparation:
 - RCC in-line
 - RCC + Plasma in-line
 - RCC + Platelet in-line
 - WB in-line
- High leukocyte depletion acc. EU guidelines ($\lll 1 \times 10^6$ WBC/unit)
- Excellent physical characteristics for preparation and storage
- High quality, monitored assembly and welding for safe blood products
- User-friendly designed elements for efficient processing
- Well proven blood bag shape for high volume and cell recovery
- Wide compatibility with blood bag accessories and devices
- Fully implemented ISO norm 3826, part 1 - 3



Dimensions

A variety of in-line blood bag systems with different sizes, additives and storage solutions are available for your individual requirements.

Ordering information

PQ31450	CompoSelect® Quadruple CPD/SAG-M T&T WB, 450 ml, 15*/20** pcs/box
PQ31470	CompoSelect® Quadruple CPD/SAG-M T&T WB, 500 ml, 15*/20** pcs/box
PQ32250	CompoSelect® Quadruple CPD/SAG-M T&B RCC, 450 ml, 15*/24** pcs/box
PQ32270	CompoSelect® Quadruple CPD/SAG-M T&B RCC, 500 ml, 15*/24** pcs/box
PQ32350	CompoSelect® Quadruple CPD/SAG-M T&B RCC/Plasma, 450 ml, 15*/24** pcs/box
PQ31850	CompoSelect® Quadruple CPD/SAG-M - RCC/PLT, 450 ml, 15*/24** pcs/box

* In Multivac packaging

** In Flow wrap packaging

These article codes are only exemplary. For more information, literature, technical details and working instructions as well as for equipment please contact your local sales representative or us.

CompoSelect® Premium

P	S-single	1-CPDA-1	1-T&T	2-RCC	5 - 450 ml	0
P	D-double	3-CPD/SAG-M	2-T&B	3-RCC/Plasma	7 - 500 ml	
P	T-triple			4-WB		
P	Q-quadruple					

Typical standard configurations are:

PQ31450 PQ32250 PQ32350



PQ31470 PQ32270 PQ31850

All articles with standard bag breaker

Certifications

- CE marked Class IIb accord. EC-Directive 93/42/EEC

Other products related to CompoSelect® that may be of interest to you

		
CompoFlex® blood bags	CompoFlow® Flexible and CompoFlow® Select	CompoMat® G5

CompoFlex®

Blood bag systems
for whole blood
collection and
processing



High quality blood bags designed for most secure blood collection, separation, preservation and transfusion



Major benefits of CompoFlex® are:

- Excellent physical characteristics for preparation and storage
- High quality, monitored assembly and welding for safe blood products
- User-friendly designed elements for efficient processing
- Well proven blood bag shape for high volume and cell recovery
- Wide compatibility with blood bag accessories and devices
- Fully implemented ISO norm 3826, part 1 - 3



CompoFlex® Premium

Dimensions

A variety of blood bag systems with different sizes, additives and storage solutions are available for your individual requirements. You will find an overview of what the article codes mean on the next pages.

Ordering information CompoFlex® Premium

PS11140	CompoFlex® Single, CPDA-1, 350 ml, 30*/40** pcs/box
PS11150	CompoFlex® Single, CPDA-1, 450 ml, 30*/40** pcs/box
PD11140	CompoFlex® Double, CPDA-1, 350 ml, 30*/40** pcs/box
PD11150	CompoFlex® Double, CPDA-1, 450 ml, 30*/40** pcs/box
PT31150	CompoFlex® Triple, CPD/SAG-M T&T, 450 ml, 24*/28** pcs/box
PT32150	CompoFlex® Triple, CPD/SAG-M T&B, 450 ml, 24*/28** pcs/box
PQ31150	CompoFlex® Quadruple, CPD/SAG-M T&T, 450 ml, 24*/28** pcs/box
PQ32150	CompoFlex® Quadruple, CPD/SAG-M T&B, 450 ml, 24*/28** pcs/box

* In Multivac packaging

** In Flow wrap packaging

These article codes are only exemplary. For more information, literature, technical details and working instructions as well as for equipment please contact your local sales representative or us.



CompoFlex® Premium

P	S-single	1-CPDA-1	1-T&T	1-without filter	4 - 350 ml 5 - 450 ml	0
P	D-double	3-CPD/SAG-M	2-T&B			
P	T-triple					
P	Q-quadruple					

Typical standard configurations are:

PS11140 PS11150 PT31150 PT32150
PD11140 PD11150 PQ31150 PQ32150

CompoFlex® Basic

Dimensions

A variety of blood bag systems with different sizes, additives and storage solutions are available for your individual requirements. You will find an overview of what the article codes mean on the next pages.

Ordering information CompoFlex® Basic

T111140	CompoFlex® Single, CPDA-1, 350 ml, 48 pcs/box
T111150	CompoFlex® Single, CPDA-1, 450 ml, 48 pcs/box
T211140	CompoFlex® Double, CCPDA-1, 350 ml, 30 pcs/box
T211150	CompoFlex® Double, CPDA-1, 450 ml, 30 pcs/box
T331150	CompoFlex® Triple, CPD/SAG-M T&T, 450 ml, 24 pcs/box
T332150	CompoFlex® Triple, CPD/SAG-M T&B, 450 ml, 24 pcs/box
T431150	CompoFlex® Quadruple, CPD/SAG-M T&T, 450 ml, 24 pcs/box
T432150	CompoFlex® Quadruple, CPD/SAG-M T&B, 450 ml, 24 pcs/box

These article codes are only exemplary. For more information, literature, technical details and working instructions as well as for equipment please contact your local sales representative or us.



CompoFlex® Basic

T	1-single	1-CPDA-1	1-T&T	1-without filter	4 - 350 ml	0
T	2-double	3-CPD/SAG-M	2-T&B		5 - 450 ml	
T	3-triple					
T	4-quadruple					





Typical standard configurations are:

T111140 T111150 T331150 T332150
T211140 T211150 T431150 T432150

Certifications

- CE marked Class IIb accord. EC-Directive 93/42/EEC

Other products related to CompoFlex® that may be of interest to you

		
<p>BioR</p>	<p>CompoSelect®</p>	
		
<p>CompoFlow® Flexible and CompoFlow® Select</p>	<p>CompoMat® G5</p>	<p>BioP</p>

CompoFlow[®] Flexible and CompoFlow[®] Select

New blood bag systems
for blood component
preparation





 **CompoFlow System**
simply ahead

The CompoFlow®
Systems offer flexible
and individual
processing, simple
and safe handling



The CompoFlow® Cap is the ideal automatic bag breaker intended for those situations where a health care professional opens hundreds of bags every day and physical strain can become a health issue.

At the heart of the CompoFlow® concept is the CompoFlow® Cap, a simple closure device that replaces the traditional bag breaker. All CompoFlow® Flexible and Select blood bag systems are equipped with this cap. The cap is automatically squeezed open using the new generation CompoMat® G5 blood component separator.

Major benefits of CompoFlow® Systems are:

- Combines all advantages of CompoFlex® and CompoSelect® Systems with well accepted CompoFlow® technology
- Full range of in-line filter systems and standard blood bag systems available
- Shorter separation time by enlarged free lumen of CompoFlow® Caps
- Reduces hemolytic incidents caused by insufficiently opened bag breakers
- Reduced risk of Repetitive Strain Injuries (RSI)
- Higher plasma recovery
- Further reduced separation time for CompoFlow® Systems in T&B configuration with new Wide Bore tubing (up to 27% for CompoFlow® Select RCC in-line systems)

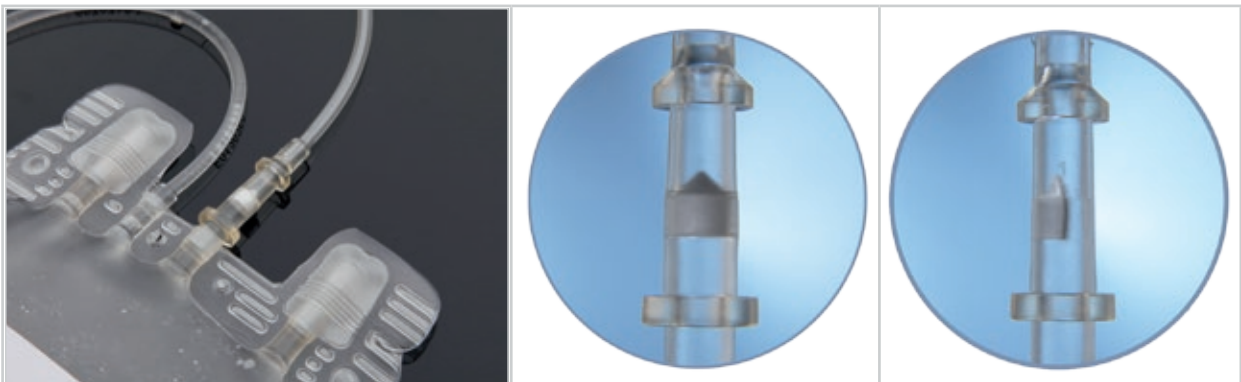

Dimensions

A variety of CompoFlow® in-line filter systems and CompoFlow® standard blood bag systems with different sizes, additives and storage solutions are available for your individual requirements.

Ordering information

CT31150	CompoFlow® Flexible Triple, 63 ml CPD/100 ml SAGM - PDS-V, 28 pcs/box
CT32150	CompoFlow® Flexible Triple, T&B 63 ml CPD/100 ml SAG-M - PDS-V, 28 pcs/box
CQ31150	CompoFlow® Flexible Quadruple, 63 ml CPD/100 ml SAG-M - PDS-V, 28 pcs/box
CQ32150	CompoFlow® Flexible Quadruple, T&B 63 ml CPD/100 ml SAG-M - PDS-V, 28 pcs/box
CQ31450	CompoFlow® Select Quadruple, 63 ml CPD/100 ml SAG-M - WB + PDS-V, 20 pcs/box
CQ31470	CompoFlow® Select Quadruple, 70 ml CPD/110 ml SAG-M - WB + PDS-V, 20 pcs/box
CQ32250	CompoFlow® Select Quadruple, T&B 63 ml CPD/100 ml SAG-M - RCC - PDS-V, 24 pcs/box
CQ32270	CompoFlow® Select Quadruple, T&B 70 ml CPD/110 ml SAG-M - RCC - PDS-V, 24 pcs/box
CQ32350	CompoFlow® Select Quadruple, T&B 63 ml CPD/100 ml SAG-M - RCC/ Plasma + PDS-V, 24 pcs/box

These article codes are only exemplary. For more information, literature, technical details and working instructions as well as for equipment please contact your local sales representative or us.

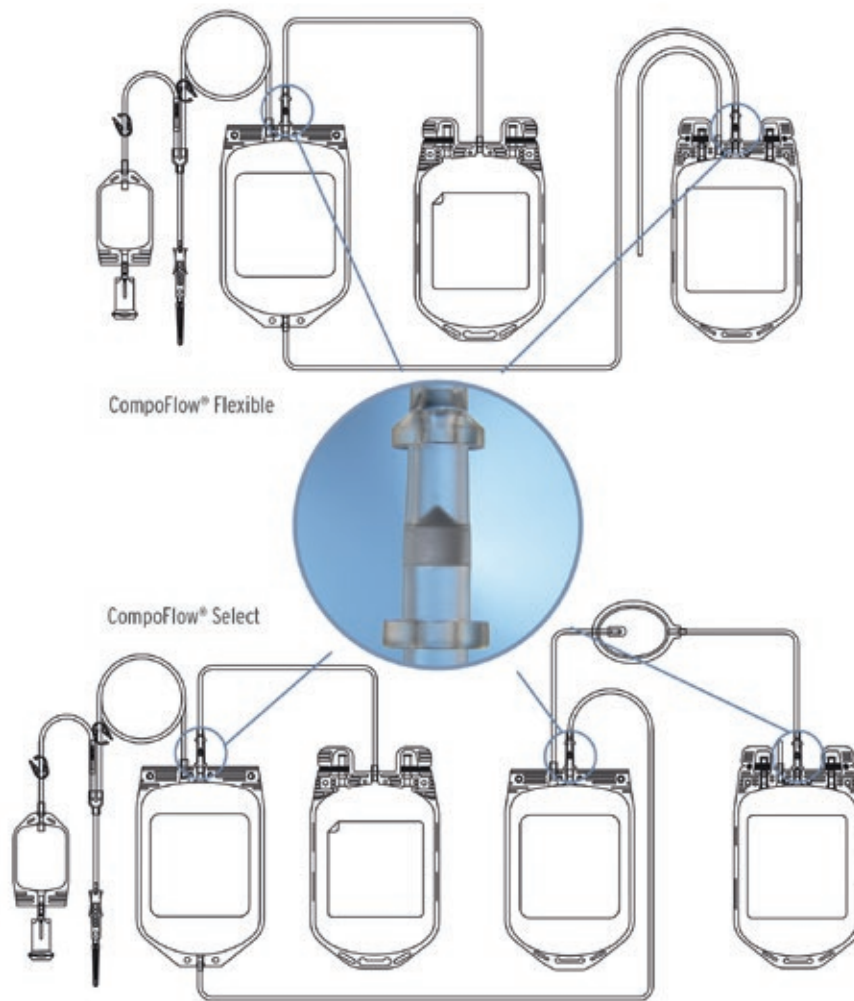

CompoFlow® Flexible and CompoFlow® Select

C	S-single	1-CPDA-1	1-T&T	1-Conventional	5 - 450 ml	0
C	D-double	3-CPD/SAG-M	2-T&B	2-RCC	7 - 500 ml	
C	T-triple			3-RCC/Plasma		
C	Q-quadruple			4-WB		

Typical standard configurations are:

CT31150

CT32150

CQ31150

CQ32150

CQ31450

CQ31470

CQ32250

CQ32270

CQ32350

All articles with CompoFlow® Cap

Certifications

- CE marked Class IIb accord. EC-Directive 93/42/EEC

Other products related to CompoFlow® Systems that may be of interest to you



BioR

Leukocyte
depletion filters
for red cell
concentrates



High filtration efficiency and performance plus easy handling



Major benefits of BioR are:

- Suitable for filtration under gravity and in emergency cases with pressure up to 300 mm Hg (or 0.4 bar)
- High filtration efficiency $< 0.5 \times 10^5$ WBC/unit (BioR max)
- Excellent RBC recovery due to low volume loss
- Short filtration time < 10 min (for lab filtration)
- Melt-blown non-woven polyester fibre
- Non-ionic coated fibre surface
- Excellent wetting characteristic
- Available as blood bank or bedside use filters for up to two RBC units

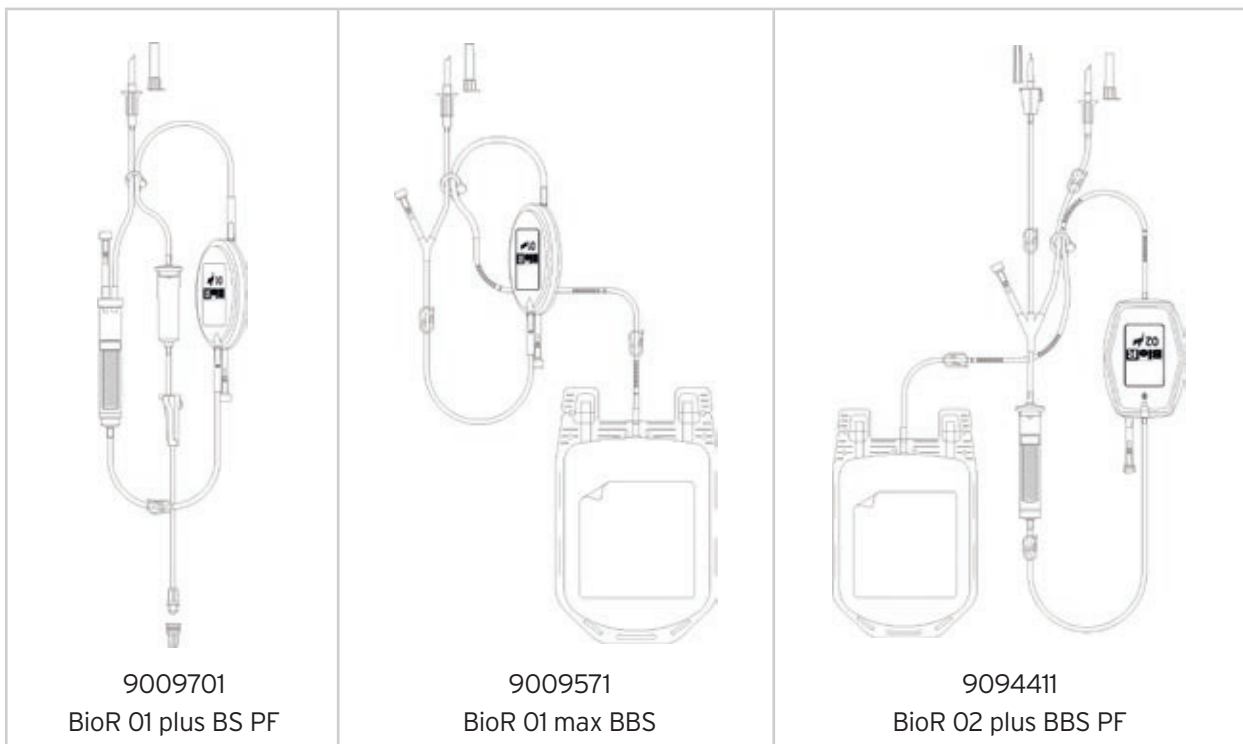

Dimensions

A variety of configurations for different preparation methods are available for your individual requirements.

Ordering information

9009701	BioR 01 plus BS PF, 40 units/box
9009711	BioR 01 plus BBS PF, 40 units/box
9009571	BioR 01 max BBS, 40 units/box
A2BA0560	BioR 01 max BBSS PF, 40 units/box
A2BB0080	BioR 02 plus BS PF, 40 units/box
9094411	BioR 02 plus BBS PF, 40 units/box

These article codes are only exemplary. For more information, literature, technical details and working instructions as well as for equipment please contact your local sales representative or us.

BioR filters

Capacity	Leukocyte depletion	Place of filtration	Options
01 = one unit of RBC concentrate	plus: $< 0.1 \times 10^6$ residual WBC max: $< 0.5 \times 10^5$ residual WBC	BS = bed side filtration BBS = laboratory filtration with one bag	PF = prefilter chamber with 200 μm filter mesh
02 = two units of RBC concentrates	plus: $< 0.2 \times 10^6$ residual WBC	BBSS = laboratory filtration with two bags	

Certifications

- CE marked Class IIa/IIb accord. EC-Directive 93/42/EEC

Other products related to BioR that may be of interest to you

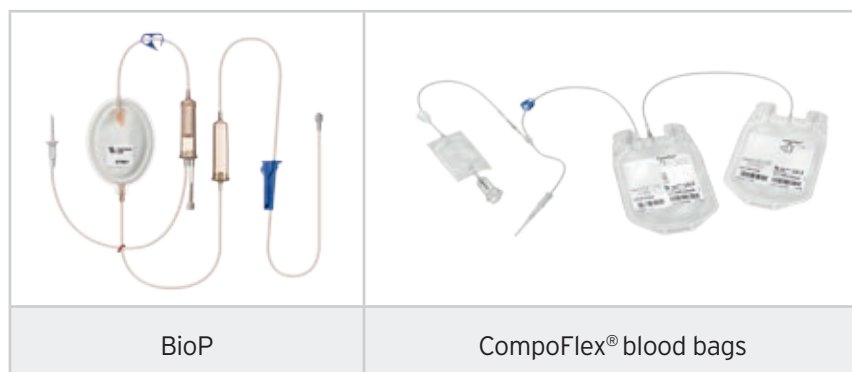

BioP

Leukocyte
depletion filters
for platelet
concentrates

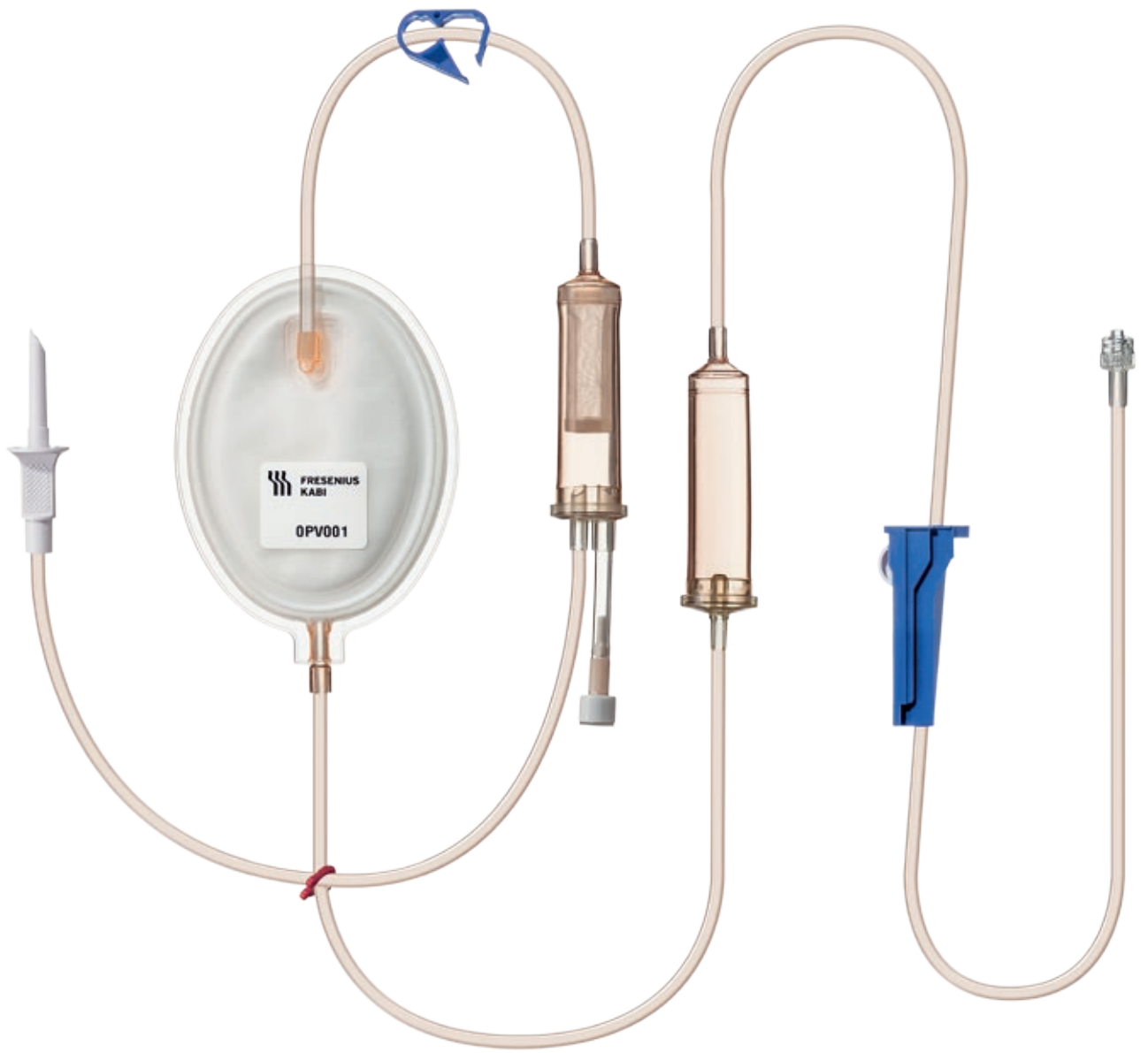

High quality blood components due to improved filtration efficiency and performance



Major benefits of BioP are:

- Suitable for filtration by gravity
- High leukocyte depletion efficiency
- Improved filtration efficiency $< 0.1 \times 10^6$ leukocytes/unit
- User friendliness due to easy handling
- High yields due to reduced hold-up volume
- Time saving due to shortened filtration time
- Melt blown non-woven polyester fibre
- Non-ionic coated fibre surface
- Excellent wetting characteristics

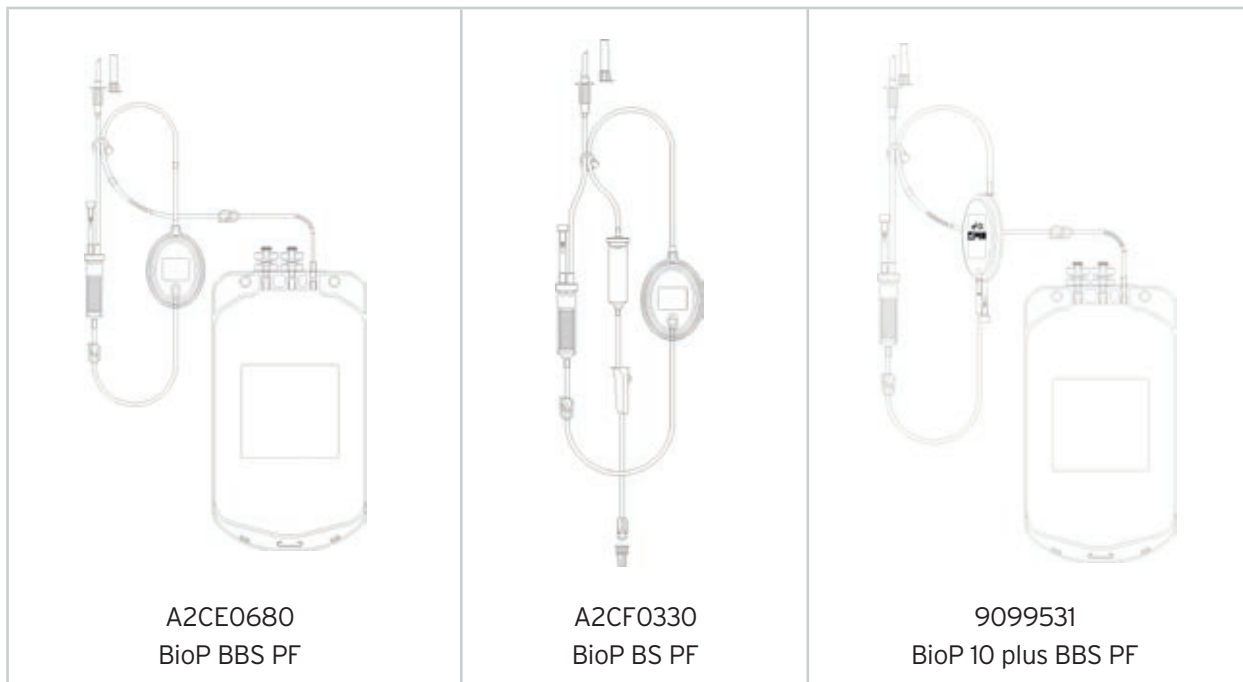

Dimensions

A variety of configurations for different preparation methods are available for your individual requirements.

Ordering information

A2CE0680	BioP BBS PF, 1300 ml (PVC-TOTM), 40 pcs/box
A2CE0690	BioP BBS PF ST, 1300/100 (PO/PVC), 40 pcs/box
A2CF0330	BioP BS PF, 40 pcs/box
9099531	BioP 10 plus BBS PF, 1300 ml (PVC-TOTM), 40 pcs/box
9099541	BioP 10 plus BS PF, 40 pcs/box

These article codes are only exemplary. For more information, literature, technical details and working instructions as well as for equipment please contact your local sales representative or us.



BioP

Capacity	Leukocyte depletion	Place of filtration	Options
05 = filtration of 4 - 6 pooled random donor platelet concentrates or an equivalent apheresis unit	$< 0.1 \times 10^6$ residual WBC	BS = bed side filtration BBS = laboratory filtration with one bag	PF = prefilter chamber with 170 μ m filter mesh
10 = for filtration of 7 to 12 random pooled platelet units or an equivalent apheresis unit	$< 0.2 \times 10^6$ residual WBC	BS = bed side filtration BBS = laboratory filtration with one bag	PF = prefilter chamber with 170 μ m filter mesh

Certifications

- CE marked Class IIa/IIb accord. EC-Directive 93/42/EEC

Other products related to BioP that may be of interest to you

		
BioR	CompoStop flex	CompoFlex® blood bags

CompoStop flex

Preparation of
leukocyte depleted
platelet concentrates
by pressure



High yields due to reduced hold-up volume and time saving because of shortened filtration time



Major benefits of CompoStop flex are:

- High PLT recovery (90%)
- Efficient leukocyte depletion (res. WBC < 0.1×10^6 /unit)
- Low RBC contamination by automatic stop function
- Easy to use by flexible filter housing
- No extra docking after the pooling procedure by integrated pooling bag
- High capacity up to 6 pooled buffy coats
- Suitable for pressure filtration at semi-automatic separators
- Suitable for pooling by chain/train or octopus-method
- Storage up to 7 days

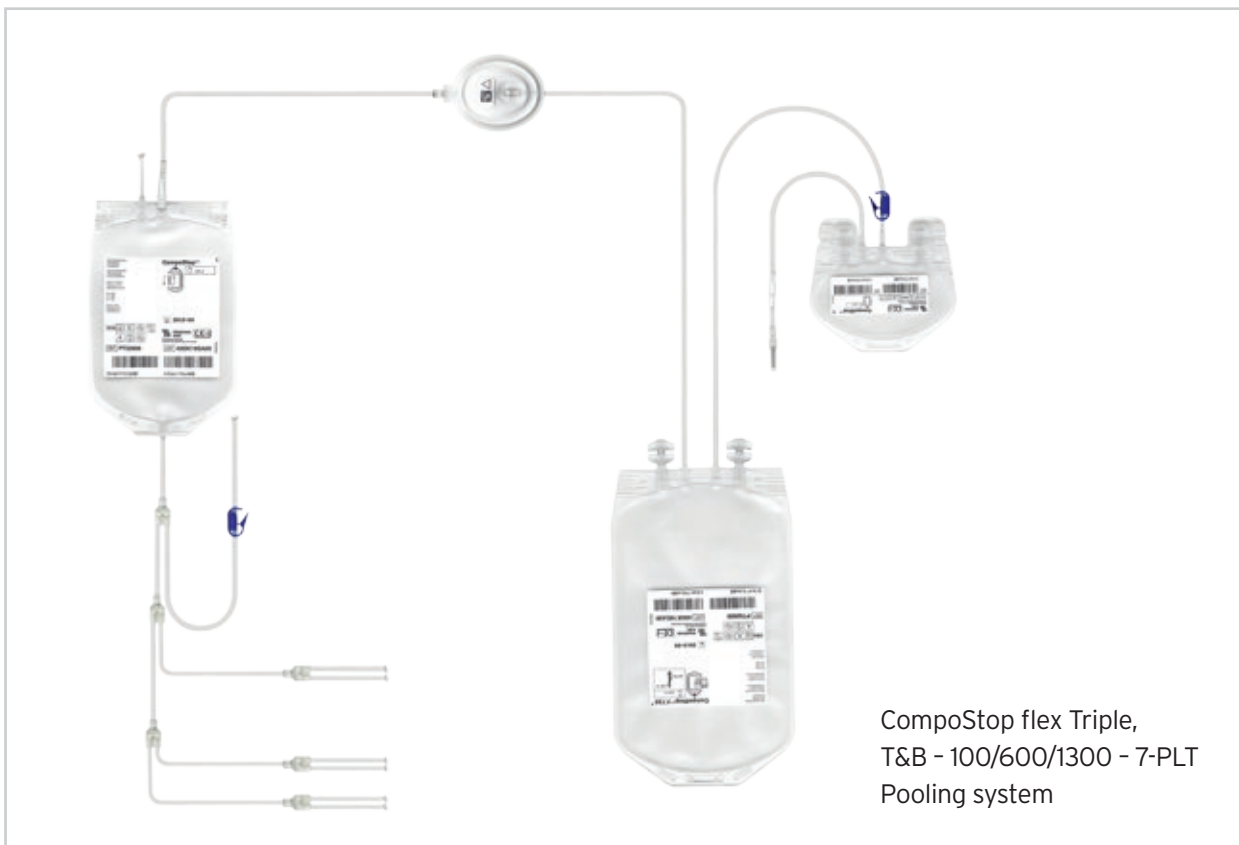

CompoStop flex Triple,
T&B - 100/600/1300 - 7-PLT
Pooling system

Dimensions

A variety of configurations for different preparation methods are available for your individual requirements.





Ordering information

PD51600	CompoStop flex Double 100 ml/1300 ml, with one tube for sterile connection of one pool buffy coat, 20 pcs/box
PT52600	CompoStop flex Triple, T&B, 100 ml/600 ml/1300 ml, with 7 tubes for sterile connection of up to 6 single buffy coats and one PAS/plasma unit, 20 pcs/box

Certifications

- CE marked Class IIb accord. EC-Directive 93/42/EEC

Other products related to CompoStop flex that may be of interest to you

	
BioP	CompoSelect®
	
CompoFlex® blood bags	CompoMat® G5

InterSol

Platelet
additive
solution





InterSol™ Solution
PL2411 280ml

Formula: Natri citraatdihydr. 318mg - Dinatri fosfaat anhyd. 365mg - Natri dihydrogenfosfaat dihyd. 109mg - Natri acetat trihyd. 442mg - Natri chloride 452mg - Aqua ad inject. ad 100ml

For processing and storage of platelets
Not for direct intravenous infusion. Use directly after overpouch removal.

Pour la préparation et le stockage des plaquettes
Ne pas administrer directement par voie intraveineuse. Utiliser immédiatement après le retrait de la surpoche.

Für die Verarbeitung und Lagerung von Thrombozyten
Nicht zur direkten intravenösen Infusion. Nach dem Entfernen der Umverpackung unverzüglich verwenden.

Voor het verwerken en opslaan van bloedplaatjes
Niet voor directe intraveneuze infusie. Onmiddellijk gebruiken na verwijdering van de beschermverpakking.

Per il trattamento e la conservazione di piastrine

Non somministrare per via endovenosa diretta. Usare immediatamente dopo la rimozione dell'involucro esterno protettivo.

Para el procesamiento y almacenamiento de plaquetas

No para infusión intravenosa directa. Utilizar directamente después de retirarlo de la sobrepoucha.

Para o processamento e conservação de plaquetas
Não se destina a perfusão intravenosa directa. Utilizar imediatamente após a remoção do invólucro exterior.

Για επεξεργασία και φύλαξη αιμοπεταλίων
Όχι για απευθείας ενδοαγγειακή έγχυση. Τα αιμοπεταλία πρέπει να παρασκευάζονται σύμφωνα με τους σχετικούς κανονισμούς.

28-57-01-131



REF R8109



2010-08

LOT 09C20L11



Extend
storage,
improve
quality



Major benefits of InterSol are:

- Decrease of plasma-related adverse transfusion reactions
- Increase of plasma volume availability for other purposes
- Compatible with pathogen reduction technologies
- Facilitates standardization

Ordering information for buffy coat platelets

KGR8109B	280 ml Languages: EN/DK/FI/NO/SE/EE/LV/LT
RGR8109B	280 ml Languages: EN/FR/DE/NL/IT/SE/DK/FI/NO

Ordering information for AMICUS apheresis platelets

CDB8110	500 ml with male luer connector Languages: EN/NL/FR/DE/IT/ES/DK/PT/FI/NO/SE/GR
CDB8110M	500 ml with green female luer connector for France Languages: EN/NL/FR/DE/IT/ES/DK/PT/FI/NO/SE/GR
CPDB8110	500 ml with male luer connector Languages: EN/TR/PL/CZ/SK/SI/HR/HU/UA
4B7850	500 ml with spike No CE mark FDA cleared for use with the AMICUS Separator Languages: EN

Please refer to the chapter on the AMICUS Separator in this catalog, for details on compatibility with the different AMICUS platelet disposables.

Certifications

- CE marked Class III

Manufacturer: Fenwal Inc., Three Corporate Drive, Lake Zurich, IL 60047, USA
EC Rep.: Fenwal Europe sprl, Rue Edouard Belin 2-4, 1435 Mont-Saint-Guibert, Belgium

Other products related to InterSol that may be of interest to you

			
CompoStop flex	CompoMat® G5	CompoDock®	AMICUS Separator

CompoSol®

Platelet
additive
solution

Composol® PS

300 ml

Platelet storage solution; use only if solution is clear, sterile and pyrogen-free.
Plaatjesbewaarfloeistof; alleen gebruiken als vloeistof helder is; steriel en pyrogenvrij.
Thrombozytenlagerlösung; nur zu verwenden wenn Lösung klar ist; steril und pyrogenfrei.
Solution pour conservation des plaquettes; à n'utiliser que si la solution est limpide; stérile et apyrogène.
Solución para la conservación de plaquetas; usar la solución solamente si esta clara; estéril y apirógena.

Διάλυμα συντήρησης αιμοπεταλίων; χρησιμοποιείται το μόνο εάν το διάλυμα είναι διαυγές, αποστειρωμένο και ελεύθερο πυρογόνων.
Soluzione conservante per piastrine; da usare solamente se la soluzione è limpida; sterile ed apirogena.
Solução para conservação de plaquetas; utilizar a solução apenas se estiver limpa; estéril e apirógena.



Formula / Formule / Formel / Composición / Σύσταση / Composizione / Compositiõ			
Sodium chloride	5.257 g	Potassium chloride.....	0.373 g
Sodium gluconate.....	5.023 g	Magn. chloride hexahydrate..	0.305 g
Sodium acetate trihydrate.....	3.675 g	Acid. hydrochloric.....	q.s ml
Sodium citrate dihydrate	3.213 g	Water for injection.....	to 1000 ml

REF **E2083**



Fresenius Kabi AG
DE- 61346 Bad Homburg



LOT **2FR00E2083**
12FDK98



00012FDK98

FRESENIUS KABI
LYB 4052 01-71-03-001B



Platelet additive solution



Major benefits of CompoSol® are:

- Decrease of plasma-related adverse transfusion reactions
- Increase of plasma volume availability for other purposes
- Facilitates standardization of the platelet processing
- Improved pH control

Ordering information

E2083

300 ml

Languages: EN/NL/DE/FR/ES/IT/PT/GR

Certifications

- CE marked Class IIb

Other products related to CompoSol® that may be of interest to you

 A medical device consisting of a clear plastic reservoir connected to a grey control unit by a white tube. The reservoir has a label and a stopcock.	 A compact, yellow and white medical device with a control panel on top and a front-loading compartment.	 A grey and yellow medical device with a flat top surface and two side handles, possibly a docking station or a specialized pump.
<p>CompoStop flex</p>	<p>CompoMat® G5</p>	<p>CompoDock®</p>

CompoMat[®] G5

The new generation
of automated
blood component
separator



CompoMat G5

CompoFlow System
simply ahead

A new generation
of an automated blood
component separator
including processing of
CompoFlow® blood bag
systems



Major benefits of CompoMat® G5 are:

- Reduces risk of RSI (Repetitive Strain Injuries) and hemolysis by automatic opening of the new bag closure CompoFlow®
- Maximizes efficiency and plasma yield by automated air removal and weighing of plasma bag in a single step
- Shortens separation time by simultaneous processing of program steps
- Optimal standardization due to sensor controlled priming of program steps
- Innovative technological platform
- CompoMat® G5 and CompoMaster® Net contribute to production according to GMP guidelines



Technical data

Dimensions (L × W × H)	550 × 360 × 500 mm (G5 w/o PL- and RCC unit) 550 × 450 × 500 mm (G5 with RCC unit) 550 × 550 × 500 mm (G5 with RCC- and PL unit)
Weight	30 kg (device), 2.8 kg (PL Unit), 1.4 kg (RCC unit)
Power supply	100 - 240 V, 50 - 60 Hz
Max. power consumption	240 VA

Ordering information

9025501	CompoMat® G5 - including front balance and two CompoFlow® openers
9025561	CompoMat® G5 - USA - including front balance
9025511	RCC/RBC unit including balance and CompoFlow® opener
9025521	Plasma unit including balance, air removal plate, sealing head and optical sensor
9025531	Filter holder for FK hard and soft housing RCC/RBC filter
9028931	Scanner for CompoMat® G5
M674781	WLAN stick for CompoMat® G5
M674791	CompoMat® G5 WLAN access point
M684151	CompoMat® G5 WLAN access point US/UK/AU
M674811	CompoMat® G5 LAN hub 5-port
M684201	CompoMat® G5 LAN hub 5-port US/UK/AU
M682081	CompoMat® G5 LAN hub 24-port
M684211	CompoMat® G5 LAN hub 24-port US/UK/AU
9025541	CompoMaster Net G5 CD-ROM and IFU
9025571	CompoMaster Net G5 CD-ROM and IFU - USA
M674811	LAN hub for cable network CompoMaster Net and G5
M674801	ELT box to connect a combined network of CompoMat® G4 and G5

Certifications

- CE/MDD Class 1 according directive 93/42/ECC amended by 2007/47/EC
- CE marked, IEC 60601-1 3rd Edition Compliant
- Cleared for sales in the US (US specific version - article code 9025561)

Other products related to CompoMat® G5 that may be of interest to you

		
CompoFlow® Flexible and CompoFlow® Select	CompoSelect®	CompoVision

CompoDock[®]

Sterile
connection
of medical
PVC tubing





Just two
manual steps
to create a
sterile
connection



Major benefits of CompoDock® are:

- It connects needs for quality, reliability and easy handling with the state of the art in sterile connection of medical PVC tubing
- It is a patented technique and enables you to make sterile connections without wafers
- It operates within a fully controlled sterile connecting process
- It enables the highly efficient chain pooling method for pooling of buffy coats
- It offers automatic documentation of the sterile connection process in terms of GMP, via DockMaster Net

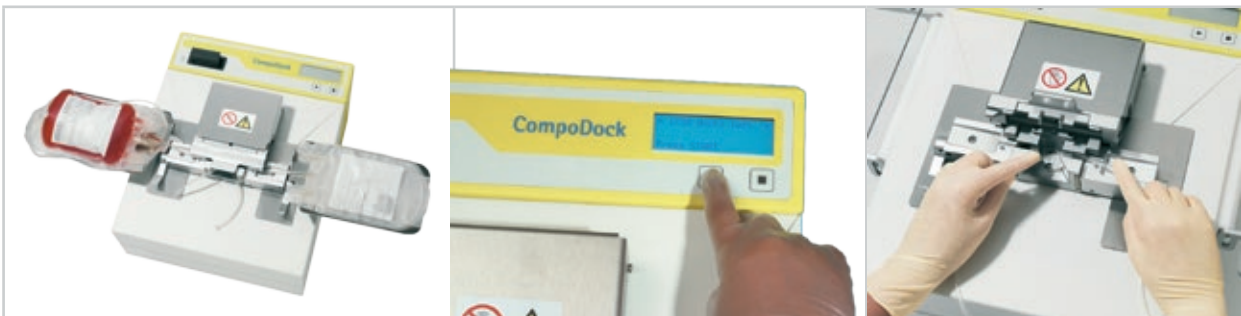

Technical data

Dimensions (L × W × H)	340 mm × 220 mm × 450 mm
Weight	22.8 kg
Power supply	100 - 120/200 - 240 Volt AC autoranging 50 - 60 Hz
Tube specification ¹⁾	Outer Ø = 3.9 - 4.6 mm, inner Ø = 2.8 - 3.1 mm
Tube specification wide bore (9028801) ¹⁾	Outer Ø = 4.6 - 5.4 mm, inner Ø = 3.0 - 4.2 mm
Tube combinations	- wet - wet - wet - dry - dry - dry

¹⁾ All medical PVC tubes complying with the DIN/ISO standard 3826

Ordering information

9028651	CompoDock® (delivered with a counter of 100 docks) Tube specification: see above
9028801	CompoDock® wide bore tubes (delivered with a counter of 100 docks)
9028721	CompoDock® 100 V AC, 50/60 Hz
9028681	CompoDock® Counter 2500 docks
9028691	CompoDock® Counter 1000 docks
9028701	CompoDock® Counter 500 docks
9028921	Software DockMaster Net, CD + User Manual
9024391	Barcode scanner
M 608141	Scanner holder
M 672351	Serial cable, socket/socket, 3 m
M 672361	Serial cable, plug/socket, 5 m





Ordering information

M 672381	Interface converter USB-Serial, 2-fold
M 672371	Interface converter USB-Serial, 4-fold
M 672391	USB cable 2.0, FullSpeed, A plug/B plug, 5 m
M 672401	USB cable 2.0, active extension, A plug/A socket, 5 m

Certifications

- CE marked
- UL approved
- Cleared for sales in the US
- Tested by the Paul-Ehrlich-Institute (PEI)

Other products related to CompoDock® that may be of interest to you

		
CompoStop flex (Pooling System)	BioP	CompoSelect®
		
CompoFlow® Flexible and CompoFlow® Select		CompoVision

Helmer Platelet Incubators and Agitators

Advanced platelet
storage systems





Advanced platelet storage systems



Major benefits of Helmer Platelet Incubators and Agitators are:

Incubators

- Superior chamber temperature uniformity with forced-air refrigeration system and precision pulse heating
- Auto-Stop/Start ensures continuous agitation of platelets
- Automatic condensate evaporator
- Roll out drawers on floor models allow easy access to the agitators inside

Agitators

- Internal single fan for forced air cooling and uniform air circulation
- Perforated drawers/shelves with non-slip texture coating
- Pull-out drawers for easy access to platelets (except PF15)
- Label holders for drawers (except PF15)

Two lines of Incubators and Agitators offer different levels of monitoring and control; i.Series® and Horizon Series™.



Technical data Incubators

Model	Series	Type	Glass doors	Interior dimensions (w × h × d) mm	Exterior dimensions (w × h × d) mm	Agitator compatibility	Net weight (kg)
PC100i	i.Series®	Benchtop	Dual-Pane	445 × 337 × 274	540 × 635 × 477	PF15i	48
PC900i	i.Series®	Benchtop	Single-Pane	566 × 401 × 451	661 × 769 × 642	PF48i	72
PC1200i	i.Series®	Benchtop	Single-Pane	896 × 401 × 451	1023 × 769 × 642	PF96i	94
PC2200i	i.Series®	Floor	Dual-Pane	928 × 896 × 458	1023 × 1524 × 712	2 × PF96i	165
PC3200i	i.Series®	Floor	Dual-Pane	928 × 1290 × 458	1023 × 1918 × 712	3 × PF96i	196
PC4200i	i.Series®	Floor	Dual-Pane	928 × 1290 × 458	1023 × 1918 × 712	Built-in	301
PC100H	Horizon Series™	Benchtop	Dual-Pane	445 × 337 × 274	540 × 635 × 477	PF15i or PF15H	48
PC900H	Horizon Series™	Benchtop	Single-Pane	566 × 401 × 451	661 × 769 × 642	PF48i or PF48H	72
PC1200H	Horizon Series™	Benchtop	Single-Pane	896 × 401 × 451	1023 × 769 × 642	PF96i or PF96H	94
PC2200H	Horizon Series™	Floor	Dual-Pane	928 × 896 × 458	1023 × 1524 × 712	2 × PF96i or 2 × PF96H	165
PC3200H	Horizon Series™	Floor	Dual-Pane	928 × 1290 × 458	1023 × 1918 × 712	3 × PF96i or 3 × PF96H	196
PC4200H	Horizon Series™	Floor	Dual-Pane	928 × 1290 × 458	1023 × 1918 × 712	Built-in	301

Power Supply: 115 V 60 Hz or 230 V 50/60 Hz

Technical data Agitators

Model	Series	Type	Dimensions (mm)	Maximum storage capacity		Drawers	Incubator compatibility	Net weight (kg)
				Standard bags	Apheresis bags			
PF15i	i.Series®	Benchtop	343 × 318 × 235	15	5 to 10	5 Stationary	PC100i or PC100H	12
PF48i	i.Series®	Benchtop	458 × 388 × 369	48	16	7 Pull-out, 1 Stationary	PC900i or PC900H	23
PF96i	i.Series®	Benchtop	851 × 388 × 369	96	32	7 Pull-out, 1 Stationary	PC1200i or PC1200H	37
PF15H	Horizon Series™	Benchtop	343 × 318 × 235	15	5 to 10	5 Stationary	PC100H	12
PF48H	Horizon Series™	Benchtop	458 × 388 × 369	48	16	7 Pull-out, 1 Stationary	PC900H	23
PF96H	Horizon Series™	Benchtop	851 × 388 × 369	96	32	7 Pull-out, 1 Stationary	PC1200H	37

Power Supply: 115 V 60 Hz or 230 V 50/60 Hz

Ordering information Incubators

PC100i	i.Series® benchtop Platelet Incubator. Compatible with one agitator PF15i
PC900i	i.Series® benchtop Platelet Incubator. Compatible with one agitator PF48i
PC1200i	i.Series® benchtop Platelet Incubator. Compatible with one agitator PF96i
PC2200i	i.Series® floor stand Platelet Incubator. Compatible with two agitators PF96i
PC3200i	i.Series® floor stand Platelet Incubator. Compatible with three agitators PF96i
PC4200i	i.Series® floor stand Platelet Incubator. Compatible with built-in agitator
PC100H	Horizon Series™ benchtop Platelet Incubator. Compatible with one agitator PF15i or PF15H
PC900H	Horizon Series™ benchtop Platelet Incubator. Compatible with one agitator PF48i or PF48H
PC1200H	Horizon Series™ benchtop Platelet Incubator. Compatible with one agitator PF96i or PF96H
PC2200H	Horizon Series™ floor stand Platelet Incubator. Compatible with two agitators PF96i or PF96H
PC3200H	Horizon Series™ floor stand Platelet Incubator. Compatible with three agitators PF96i or PF96H
PC4200H	Horizon Series™ floor stand Platelet Incubator. Compatible with built-in agitator

Ordering information Agitators





PF15i	i.Series® benchtop Platelet Agitator, 15 standard bags. Compatible with PC100i or PC100H
PF48i	i.Series® benchtop Platelet Agitator, 48 standard bags. Compatible with PC900i or PC900H
PF96i	i.Series® benchtop Platelet Agitator, 96 standard bags. Compatible with PC1200i or PC1200H
PF15H	Horizon Series™ benchtop Platelet Agitator, 15 standard bags. Compatible with PC100H
PF48H	Horizon Series™ benchtop Platelet Agitator, 48 standard bags. Compatible with PC900H
PF96H	Horizon Series™ benchtop Platelet Agitator, 96 standard bags. Compatible with PC1200H

Certifications

- CE marked
- FDA approved

Manufacturer: Helmer, Inc., 14400 Bergen Boulevard, Noblesville, Indiana, 46060, USA
 EC Rep.: Emergo Europe, Molenstraat 15, 2513 BH, The Hague, Netherlands

Other products related to Helmer Platelet Incubators and Agitators that may be of interest to you

		
<p>CompoFlow® Flexible and CompoFlow® Select</p>	<p>CompoSelect®</p>	
		
<p>CompoFlex® blood bags</p>	<p>BioP</p>	<p>CompoStop flex</p>

Helmer Plasma Thawers

Helmer QuickThaw®
Plasma Thawing Systems





Helmer
QuickThaw®
Plasma
Thawing
Systems



Major benefits of Helmer Plasma Thawers are:

QuickThaw® Plasma Thawing Systems from Helmer use both controlled temperature and agitation to substantially reduce thaw times.

- Rapid thawing
- Flexibility of starting batches of plasma at different times
- Automatically lifts the plasma bags out of the water when cycle is completed or upon high alarm activation
- Easy cleaning
- Visual heater status indicator
- Independent controls and LED display for each basket



Technical data Incubators

Model	Thawing capacity	Chamber volume (liter)	Chamber drain time (minutes)	Exterior dimensions (W × H × D) mm	Chamber dimensions (W × H × D) mm	Power supply	Net weight (kg)
DH2	2 bags	8.5	1.5	286 × 413 × 375	204 × 280 × 191	100 V 50 Hz 115 V 50/60 Hz 230 V 50/60 Hz	18
DH4	4 bags	18	3	470 × 413 × 375	394 × 280 × 191	100 V 50 Hz 115 V 50/60 Hz 230 V 50/60 Hz	26
DH8	8 bags	32	5.5	470 × 413 × 559	394 × 280 × 381	100 V 50 Hz 115 V 50/60 Hz 230 V 50/60 Hz	34

Median thaw times for plasma stored at -30°C

Bag Configuration	Time
250 ml flat	10 minutes
300 ml flat	14 minutes
250 ml flat thick plastic	16 minutes
250 ml folded	17 minutes
500 ml flat apheresis	18 minutes

Ordering information



DH2	Plasma Thawer for 2 plasma bags
DH4	Plasma Thawer for 4 plasma bags
DH8	Plasma Thawer for 8 plasma bags

Certifications

- CE marked
- FDA approved

Manufacturer: Helmer, Inc., 14400 Bergen Boulevard, Noblesville, Indiana, 46060, USA
EC Rep.: Emergo Europe, Molenstraat 15, 2513 BH, The Hague, Netherlands

Other products related to Helmer Plasma Thawers that may be of interest to you

 A medical device setup showing a pump connected to two CompoFlex blood bags via tubing.	 A medical device setup showing a pump connected to four CompoSelect blood bags via tubing.
CompoFlex® blood bags	CompoSelect®
 A medical device setup showing a pump connected to five CompoFlow blood bags via tubing.	
CompoFlow® Flexible and CompoFlow® Select	

Helmer Refrigerators and Freezers

Helmer high quality
Refrigerators and Freezers





Helmer high quality Refrigerators and Freezers



Major benefits of Helmer Refrigerators and Freezers are:

Refrigerators

- Superior chamber temperature uniformity and quick recovery with heavy-duty, air-cooled refrigeration system
- Operating temperature range from +2 °C to +10 °C
- Sure-seal self-closing door with magnetic closure
- Door-mounted controls
- Key lock

Freezers

- Superior chamber temperature uniformity and quick recovery with heavy-duty, air-cooled refrigeration system
- Operating temperature range from -15 °C to -30 °C
- Sure-seal self-closing door with magnetic closure
- Defrost can be programmed to actual time desired
- Auto condensate evaporation
- Key lock
- Door-mounted controls
- Heated door frame

Two lines of Refrigerators and Freezers offer different levels of monitoring and control; i.Series® and Horizon Series™.



Technical data Refrigerators – Blood Bank

		Type	Doors	Bag capacity (blood bag)	Interior volume (Liter)	Interior dimensions mm (w × h × d)	Exterior dimensions mm (w × h × d)	Shelves	Baskets	Drawers	Net weight (kg)
i.Series®	iB105	Undercounter	Single	66	142	496 × 502 × 559	610 × 851 × 680	0	0	2	93
	iB111	Upright	Single	165	326	508 × 1258 × 508	616 × 1791 × 623	0	0	5	160
	iB120	Upright	Single	364	572	629 × 1480 × 616	750 × 2020 × 750	0	0	7	241
	iB125	Upright	Single	504	714	629 × 1480 × 769	750 × 2020 × 902	0	0	7	254
	iB245	Upright	Double	728	1271	1397 × 1480 × 616	1505 × 2020 × 750	0	0	14	380
	iB256	Upright	Double	1008	1586	1397 × 1480 × 769	1505 × 2020 × 902	0	0	14	404
Horizon Series™	HB105	Undercounter	Single	66	142	496 × 502 × 559	610 × 851 × 680	0	0	2	91
	HB111	Upright	Single	165	326	508 × 1258 × 508	616 × 1791 × 623	0	0	5	157
	HB120	Upright	Single	364	572	629 × 1480 × 616	750 × 2001 × 750	0	0	7	240
	HB125	Upright	Single	504	714	629 × 1480 × 769	750 × 2001 × 902	0	0	7	253
	HB245	Upright	Double	728	1271	1397 × 1480 × 616	1505 × 2001 × 750	0	0	14	379
	HB256	Upright	Double	1008	1586	1397 × 1480 × 769	1505 × 2001 × 902	0	0	14	400

Power Supply: 115 V 60 Hz or 230 V 50/60 Hz

Technical data Freezers - Laboratory

	Model	Type	Volume (Liters)	Interior dimensions (w × h × d) mm	Exterior dimensions (w × h × d) mm	Shelves	Power supply	Net weight (kg)
i.Series®	iLF105	Undercounter	142	496 × 502 × 559	610 × 851 × 680	2	115 V 60 Hz 230 V 50 Hz 230 V 60 Hz	98
	iLF120	Upright	572	629 × 1480 × 616	750 × 2032 × 750	4	208/230 V 60 Hz 230 V 50 Hz	201
	iLF125	Upright	714	629 × 1480 × 769	750 × 2032 × 902	4	208/230 V 60 Hz 230 V 50 Hz	219
Horizon Series™	HLF105	Undercounter	142	496 × 502 × 559	610 × 851 × 680	2	115 V 60 Hz 230 V 50 Hz 230 V 60 Hz	95
	HLF120	Upright	572	629 × 1480 × 616	750 × 2032 × 750	4	208/230 V 60 Hz 230 V 50 Hz	200
	HLF125	Upright	714	629 × 1480 × 769	750 × 2032 × 902	4	208/230 V 60 Hz 230 V 50 Hz	217

Technical data Freezers - Plasma

	Model	Type	Volume (Liters)	Plasma boxes	Interior dimensions (w × h × d) mm	Exterior dimensions (w × h × d) mm	Drawers	Power supply	Net weight (kg)
i.Series®	iPF105	Undercounter	142	44	496 × 502 × 559	610 × 851 × 680	2	115 V 60 Hz 230 V 50 Hz 230 V 60 Hz	100
	iPF120	Upright	572	360	629 × 1480 × 616	750 × 2032 × 750	8	208/230 V 60 Hz 230 V 50 Hz	230
	iPF125	Upright	714	464	629 × 1480 × 769	750 × 2032 × 902	8	208/230 V 60 Hz 230 V 50 Hz	253
Horizon Series™	HPF105	Undercounter	142	44	496 × 502 × 559	610 × 851 × 680	2	115 V 60 Hz 230 V 50 Hz 230 V 60 Hz	98
	HPF120	Upright	572	360	629 × 1480 × 616	750 × 2032 × 750	8	208/230 V 60 Hz 230 V 50 Hz	228
	HPF125	Upright	714	464	629 × 1480 × 769	750 × 2032 × 902	8	208/230 V 60 Hz 230 V 50 Hz	252

Ordering information Refrigerators – Blood Bank

iB105	i.Series® Undercounter Blood Bank Refrigerator 142 L, 66 bags
iB111	i.Series® Upright Blood Bank Refrigerator 326 L, 165 bags
iB120	i.Series® Upright Blood Bank Refrigerator 572 L, 364 bags
iB125	i.Series® Upright Blood Bank Refrigerator 714 L, 504 bags
iB245	i.Series® Upright Blood Bank Refrigerator 1271 L, 728 bags
iB256	i.Series® Upright Blood Bank Refrigerator 1586 L, 1008 bags
HB105	Horizon Series™ Undercounter Blood Bank Refrigerator 142 L, 66 bags
HB111	Horizon Series™ Upright Blood Bank Refrigerator 326 L, 165 bags
HB120	Horizon Series™ Upright Blood Bank Refrigerator 572 L, 364 bags
HB125	Horizon Series™ Upright Blood Bank Refrigerator 714 L, 504 bags
HB245	Horizon Series™ Upright Blood Bank Refrigerator 1271 L, 728 bags
HB256	Horizon Series™ Upright Blood Bank Refrigerator 1586 L, 1008 bags

Ordering information Freezers - Laboratory

iLF105	i.Series® Undercounter Laboratory Freezer -20/30°, 142 L, 2 shelves
iLF120	i.Series® Upright Laboratory Freezer -30°, 572 L, 4 shelves
iLF125	i.Series® Upright Laboratory Freezer -30°, 714 L, 4 shelves
HLF105	Horizon Series™ Undercounter Laboratory Freezer -20/30°, 142 L, 2 shelves
HLF120	Horizon Series™ Upright Laboratory Freezer -30°, 572 L, 4 shelves
HLF125	Horizon Series™ Upright Laboratory Freezer -30°, 714 L, 4 shelves

Ordering information Freezers - Plasma



iPF105	i.Series® Undercounter Plasma Freezer -30°, 142 L, 44 boxes, 2 drawers
iPF120	i.Series® Upright Plasma Freezer -30°, 572 L, 360 boxes, 8 drawers
iPF125	i.Series® Upright Plasma Freezer -30°, 714 L, 464 boxes, 8 drawers
HPF105	Horizon Series™ Undercounter Plasma Freezer -30°, 142 L, 44 boxes, 2 drawers
HPF120	Horizon Series™ Upright Plasma Freezer -30°, 572 L, 360 boxes, 8 drawers
HPF125	Horizon Series™ Upright Plasma Freezer -30°, 714 L, 464 boxes, 8 drawers

Certifications

- CE marked
- FDA approved

Manufacturer: Helmer, Inc., 14400 Bergen Boulevard, Noblesville, Indiana, 46060, USA
EC Rep.: Emergo Europe, Molenstraat 15, 2513 BH, The Hague, Netherlands

Other products related to Helmer Refrigerators and Freezers that may be of interest to you

	
CompoFlex® blood bags	CompoSelect®
	
CompoFlow® Flexible and CompoFlow® Select	

Hematype[®]

Segment
sampling
device





Enhancing SAFETY
for operators is
making Hematype® a
predominant choice
for all segment
sampling



Major benefits of Hematype® are:

- Eliminates the risks of using scissors and minimizes blood splatters
- Reduces sharp injuries and blood exposure to operators
- Helps centers to comply with EU Directive 2000/54/EC
- Designed to fit both 10 mm and 12 mm plastic and glass test tubes

Handling instructions

STEP 1

Set the test tube in a rack.
Place the Hematype®
Segment sampling device on
top of the test tube.

STEP 2

Cover one end of the
segment with gloved hand*,
insert the other end of the
segment into the Hematype®
Segment sampling device
and squeeze to obtain a
sample.

(* Avoids spray from improperly
sealed segment)

STEP 3

Recommended method of
segment disposal:
Hold the Hematype®
Segment sampling device
with the segment in place
and discard both into
an approved biohazard
medical waste container.

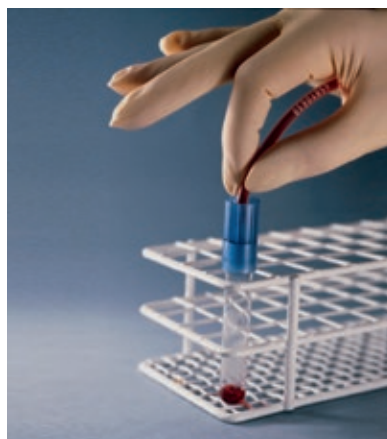

Ordering information

4R5126	2,000 units per carton
4R5128F	1,000 units per carton
R4R5128F	1,000 units per carton (CE Marked)

Manufacturer: Fenwal Inc., Three Corporate Drive, Lake Zurich, IL 60047, USA
EC Rep.: Fenwal Europe sprl, Rue Edouard Belin 2-4, 1435 Mont-Saint-Guibert, Belgium

Other products related to Hematype® that may be of interest to you

		
CompoCool®	CompoSeal Mobilea II	CompoSeal Universal

CompoVision

Real-time and offline
data visualization for
CompoMat® G5, CompoDock®
and CompoGuard®



Making
efficiency
visible

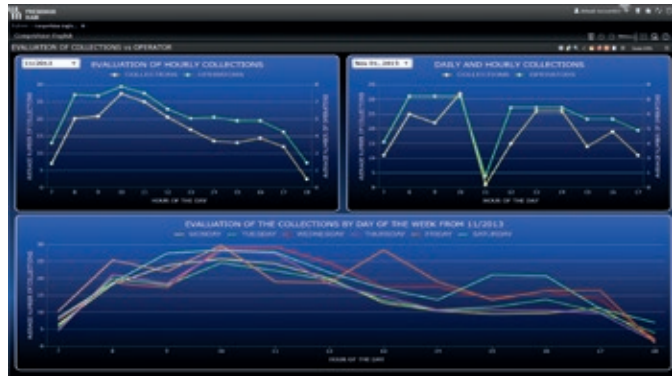

CompoVision is a supporting software for CompoMaster® Net, DonationMaster Net and DockMaster Net. It visualizes generated data in real-time as well as offline. By visualizing the collection and processing data, it increases process efficiency, product yield and quality.

Major benefits of CompoVision are:

- Unique data visualization, in real-time as well as offline
- Customer-friendly opportunity to easily track different processes
- Support in the post-processing (e.g. evaluation, reporting)
- Shows and confirms reliability and efficiency of the devices
- Data can also be displayed via iPad or iPhone (real-time)

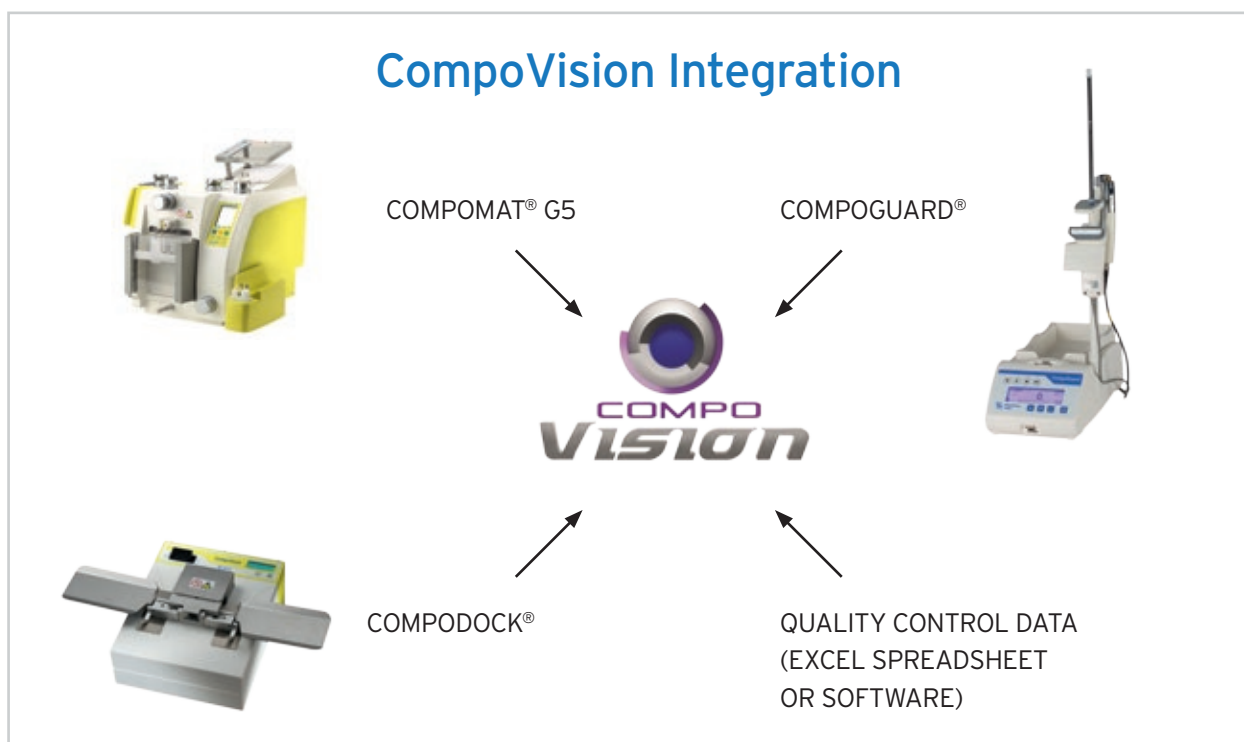

Other products related to CompoVision that may be of interest to you

		
CompoGuard®	CompoMat® G5	CompoDock®

RFID Technology

Blood
tracking and
traceability
system



Automatic,
wireless
data transfer
throughout whole
blood processing
in real-time

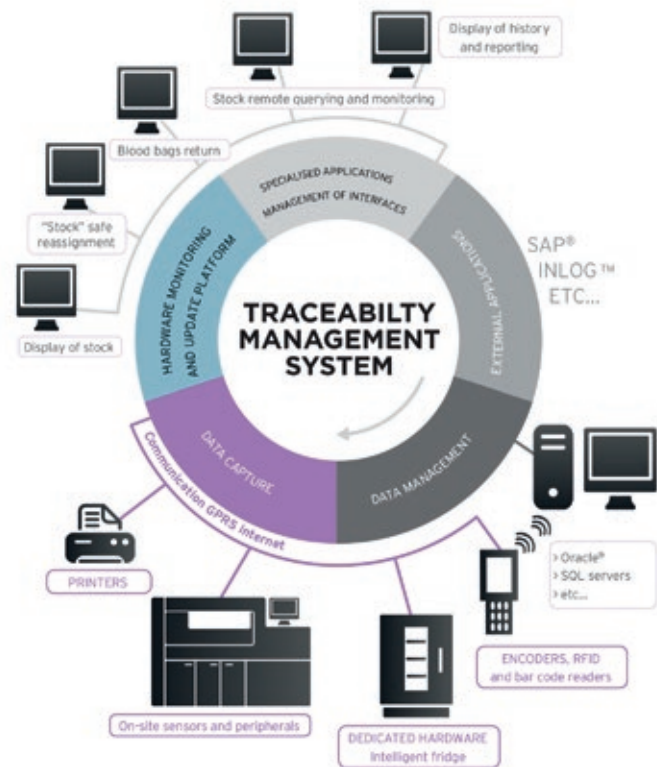

Fresenius Kabi RFID technology enables you to efficiently manage your blood bag stocks by giving you real-time information on their status, location and availability.

It improves the safety and cost efficiency of the whole logistic flow including storage of blood components during or at the end of the preparation process. Manual counting and scanning is replaced by automatic wireless reading.

Moreover, the real-time matching of data coming from different sources prevents mistakes connected to patient identification and medical application.

Major benefits of the RFID Technology are:

- RFID tag architecture according to international transfusion guidelines¹
- Several years of experience in transfusion related applications
- Complete portfolio containing hard- and software modules
- User-friendly information system for tracing and tracking of blood components
- Temperature control during transport of blood available

¹ Guidelines for the Use of RFID Technology in Transfusion Medicine - Version 1.0; Vox Sang, April 2010

Ordering information

n.a.	RFID tags with 0.5 k, 1.0 k or 2.0 k bytes memory capacity
n.a.	Workstation (RFID reader and PC)
n.a.	Labelling station (RFID printer)
n.a.	Biotemp access point
n.a.	Biotemp datalogger
n.a.	Equipment for fridges and cold room
n.a.	Server licences for mono site, multi site or global server

These article codes are only exemplary. For more information, literature, technical details and working instructions as well as for equipment please contact your local sales representative or us.

Certifications

- HF ISO18000-3 Mode 1
International standard for passive RFID item level identification
- ISO15693
ISO standard for vicinity cards

EC Rep.: biolog-id, 1, Rue du Commandant Robert Malrait, 27300 Bernay, France

Other products related to RFID Technology that may be of interest to you

	
Helmer Refrigerator	Helmer Platelet Agitator

Manual Plasma Extractor

Durable and reliable
Manual Plasma Extractor





Durable
and reliable
Manual
Plasma
Extractor



Intended use of Plasma Extractor:

The Manual Plasma Extractor is designed for pressing standard PVC blood bags to extract plasma/platelets from whole blood manually.

The press provides constant pressure from bottom up to extract plasma/platelets from whole blood manually.

Ordering information

R4R4460



Manual Plasma Extractor

Certifications

- CE marked

Manufacturer: Fenwal Inc., Three Corporate Drive, Lake Zurich, IL 60047, USA
EC Rep.: Fenwal Europe sprl, Rue Edouard Belin 2-4, 1435 Mont-Saint-Guibert, Belgium

Other products related to Manual Plasma Extractor that may be of interest to you

 A medical setup showing a CompoFlex blood bag connected to a manual plasma extractor. The bag is a large, clear plastic container with a white label and a blue cap. It is connected to a clear plastic tube that leads to a small, rectangular, light-colored device with a blue handle and a clear window.
<p>CompoFlex® blood bags</p>
 A medical setup showing a CompoSelect manual plasma extractor. It consists of a central, light-colored, rectangular device with a blue handle and a clear window. This device is connected to a network of clear plastic tubes that lead to four separate, smaller, clear plastic containers (bags) arranged in a row. Each bag has a white label and a blue cap.
<p>CompoSelect®</p>
 A medical setup showing a CompoFlow manual plasma extractor. It features a central, light-colored, rectangular device with a blue handle and a clear window. This device is connected to a network of clear plastic tubes that lead to five separate, smaller, clear plastic containers (bags) arranged in a row. Each bag has a white label and a blue cap.
<p>CompoFlow® Flexible and CompoFlow® Select</p>

4. SPECIALIZATION

CompoFlex[®] Transfer Bags

CompoFlex[®] Transfer Bags
for special applications





CompoFlex® Transfer Bags for special applications



Major benefits of CompoFlex® Transfer Bags are:

- Gamma or steam sterilized systems
- High variety of different adapters for wide range of connectivity
- Bag sizes from 17 ml up to 1,000 ml available
- Pediatric systems for RBC and PLT preparation and storage



Dimensions

A variety of different transfer bag systems in different sizes and adapters is available.

Ordering information

P 4158	150 ml, Luer-Lock male, PVC/DEHP
P 4159	4 × 150 ml, Spike, PVC/DEHP
P 4160	150 ml, Spike, PVC/DEHP
P 4161	3 × 300 ml, Haemonetics, PVC/DEHP
P 4162	500 ml, Spike, PVC/DEHP
P 4164	300 ml, Spike, PVC/DEHP
P 4165	3 × 300 ml, Spike, PVC/DEHP
P 4201	2 × 600 ml, Spike, PVC/DEHP
P 4203	2 × 600 ml, Cannula, PVC/DEHP
P 4206	100 ml, closed tube, PVC/DEHP
P 4220	600 ml, Pigtail, PVC/DEHP
P 4214	4 × 400 ml, Pigtail, PVC/DEHP
P 4224	4 × 500 ml, Pigtail, PVC/Hexamoll® DINCH
T 2110	1,300 ml, Pigtail, PVC/Citrate

These article codes are only exemplary. For more information, literature, technical details and working instructions as well as for equipment please contact your local sales representative or us.

Certifications

- CE marked Class I acc. MDD

Other products related to CompoFlex® Transfer Bags that may be of interest to you

	
CompoFlex® blood bags	CompoMat® G5

CB COLLECT

For collection
of umbilical
cord
blood





For collection
of umbilical
cord blood



Major benefits of CB COLLECT are:

- Cord blood collection set for easy use
- Primary 300 ml bag filled with 20 ml CPD
- Additional 10 ml CPD bag to adjust the amount of coagulants to the respectively collected volume of cord blood
- Two needles for double venipuncture and maximum cord blood collection
- Single packed set
- In combination with P 4208 CompoFlex® Processing Set becomes ideal for places where collection and preparation is carried out at different locations



Ordering information

T2950

CB COLLECT Double, 300 ml, 20 ml + 10 ml CPD, 30 pcs/box

Certifications

- CE marked Class IIb accord. EC-Directive 93/42/EEC

Other products related to CB COLLECT that may be of interest to you

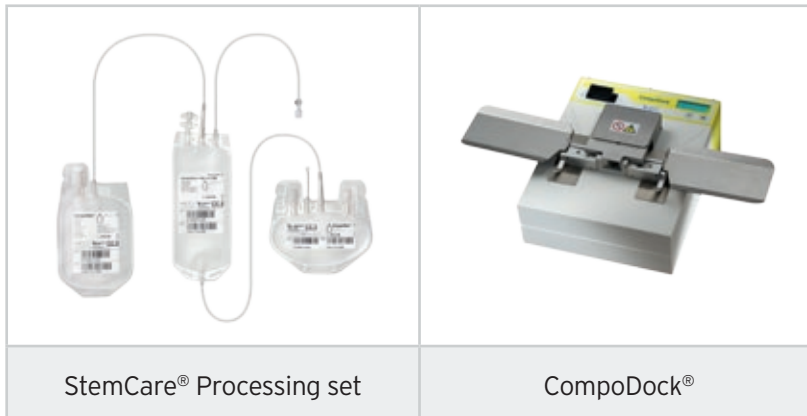

Stemcare[®] Set

To process umbilical
cord blood
by centrifugation
and separation



To process
umbilical
cord blood by
centrifugation
and
separation



Major benefits of Stemcare® Set are:

- Optimized design of the processing container with two transfer bags to separate plasma and erythrocyte concentrate from buffy coat
- Luer-lock-adapter for easy buffy coat collection
- The central low volume top & bottom bag is optimal for centrifugation and preparation of buffy coat
- In combination with T 2950 CB COLLECT ideal for laboratories performing centrifugation and separation of buffy coat in two distinct devices



Ordering information

P4208	StemCare® Processing Set Triple, T&B, 200 ml/150 ml/100 ml, 35 pcs/box
-------	--

Certifications

- CE marked Class IIb accord. EC-Directive 93/42/EEC

Other products related to Stemcare® Set that may be of interest to you

		
CB COLLECT	CompoMat® G5	CompoDock®

Bone Marrow Collection Kit

Collection
and gravity-flow
filtration
system





To collect and filter aspirated bone marrow for autologous or allogeneic transplantation

Major benefits of Bone Marrow Collection Kit are:

- Components for collection and filtration in one kit aseptically wrapped for presentation
- Easy set up of the kit
- Convenient filtration by gravity flow
- Collection container can comprise up to 1.2 L of bone marrow aspirate
- Additional injection sites on collection container and transfer packs
- Woven mesh filters ranging from 850 to 500 micron reduce likelihood of clogging during filtration process

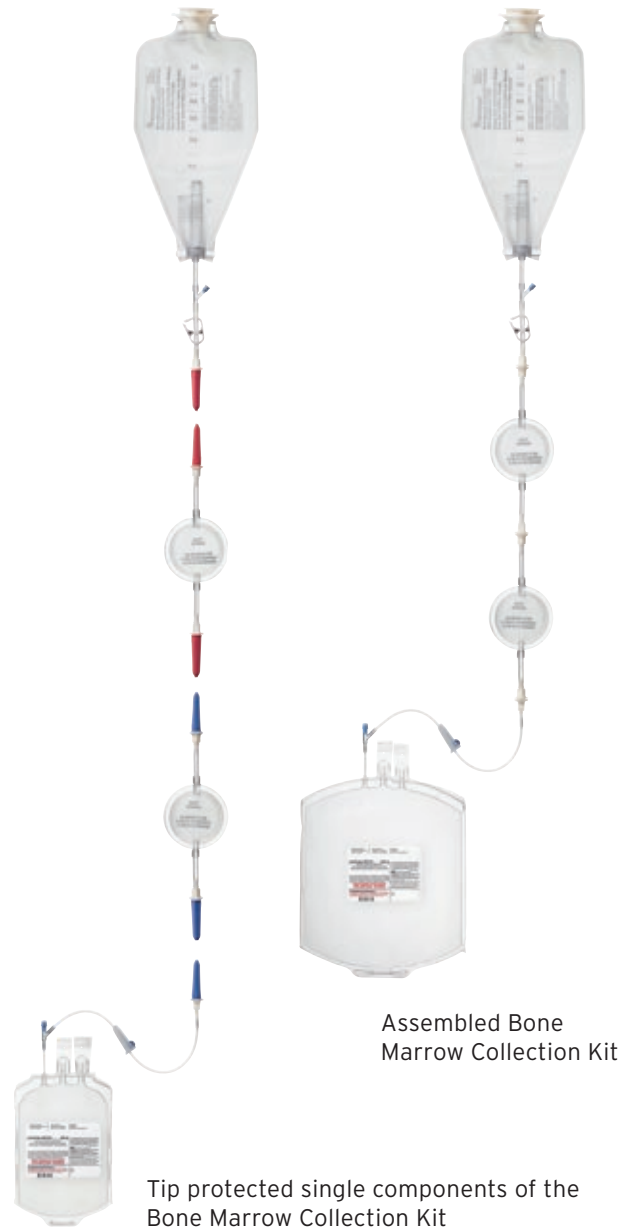

Ordering information

R4R2107H	Bone Marrow Collection Kit with Pre-filter and In-line filters (CE-marked), 1 unit
R4R2107J	Bone Marrow Collection Kit with Pre-filter and In-line filters (only sold in Japan), 1 unit
4R2107H	Bone Marrow Collection Kit with Pre-filter and In-line filters, 1 unit
4R2105	Bone Marrow Collection Kit stand

Certifications

- CE marked and non-CE marked

Manufacturer: Fenwal Inc., Three Corporate Drive, Lake Zurich, IL 60047, USA
 EC Rep.: Fenwal Europe sprl, Rue Edouard Belin 2-4, 1435 Mont-Saint-Guibert, Belgium

Other products related to Bone Marrow Collection Kit that may be of interest to you

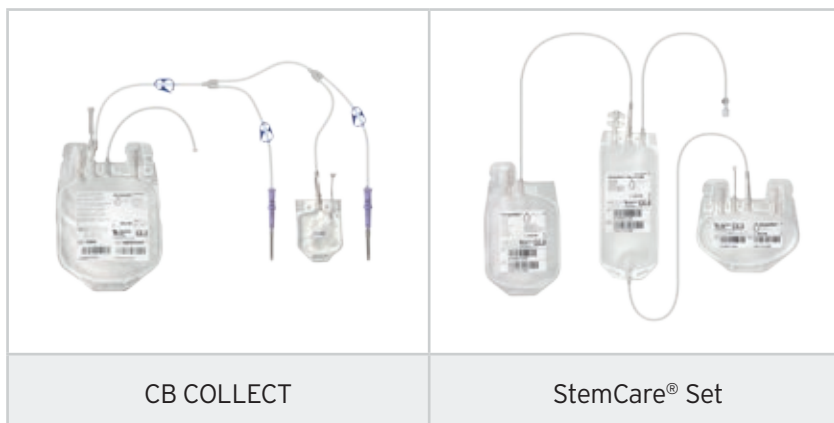

HemoFreeze

Freezing bags
and accessories
for long term storage
in liquid nitrogen



Safe and reliable
cryogenic
preservation



Fresenius Kabi's freezing bags offer maximum stability for long-term storage of precious and delicate material, such as:

- Stem cells
- Bone marrow
- Erythrocytes and platelets
- Tissues and grafts
- Heart valves and bones

at low temperatures for specific transfusion and transplantation requirements.

Major benefits of HemoFreeze are:

- The cryopreservation bags are made of biocompatible Kapton®/Teflon® material, free of plasticizers that do not stick together in the freezer. They offer high resistance and stability, even at temperatures as low as -196 °C in liquid or gas-phase nitrogen.
- There are two categories of HemoFreeze bags available: closed bags for blood components and bone marrow as well as open bags for grafts, bones, tissues and heart valves. A separate glycerolisation set is available. Closed bags can be filled with the help of a transfer set. Open bags are to be filled via the non-sealed bottom.

Ordering information for cryopreservation of blood components and bone marrow

Z 2002	100 ml bag with 3 connectors
Z 2004	350 ml bag with 3 connectors
Z 2008	600 ml bag with 3 connectors
Z 2014	60 ml bag with 3 connectors

Ordering information for cryopreservation of grafts, bones, tissues and heart valves

Z 2009	Open bag with 3 connectors Dimensions: 630 mm × 290 mm
Z 2010	2 open bags without connectors Dimensions: 95 mm × 153 mm and 133 mm × 210 mm
Z 2011	2 open bags without connectors Dimensions: 133 mm × 210 mm and 163 mm × 250 mm
Z 2012	Open bag with 3 connectors Dimensions: 352 mm × 153 mm

Certifications

- CE marked Class IIa

The signs/names marked with ® are registered trademarks of the Fresenius Group in selected countries.

Helmer®, i.Series®, Horizon Series™ and QuickThaw® are registered trademarks or trademarks of Helmer, Inc. in the United States of America.



**FRESENIUS
KABI**

caring for life

Fresenius Kabi AG

Else-Kroener-Strasse 1
61352 Bad Homburg, Germany
Phone: +49 (0) 61 72 686 7276
Fax: +49 (0) 61 72 686 4728
www.fresenius-kabi.com